

Life Is On

Schneider
Electric



Pricebook Retail 2025

Schneider Indonesia berdiri sejak

1973 **52** Tahun



Tahun 2019

Perusahaan yang paling dikagumi di Dunia.

– dari Fortune, untuk Industri Elektronik

Pemimpin Industri

Dalam Indeks **Dow Jones Sustainability (DJSI)** selama 3 tahun berturut-turut dan "Industry Motver" untuk kemajuan proporsional terbaik pada performa keberlanjutannya dari tahun lalu.

Schneider Electric

~137.000

Karyawan di 100+ Negara

♀ **30%**
Karyawan kami adalah wanita

Meraih penghargaan:
World's Most Sustainable Companies 2024 - TIME

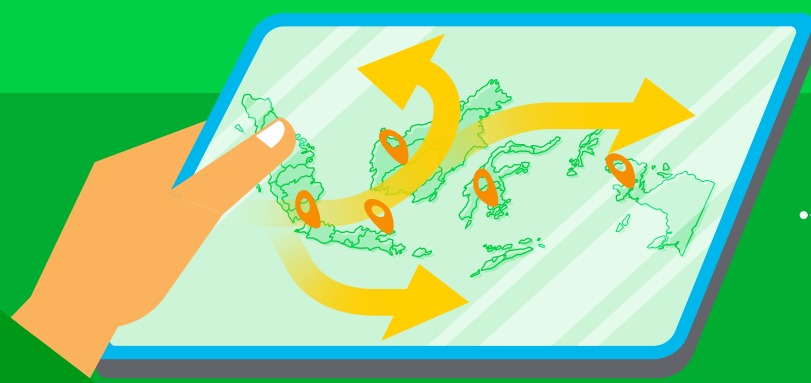
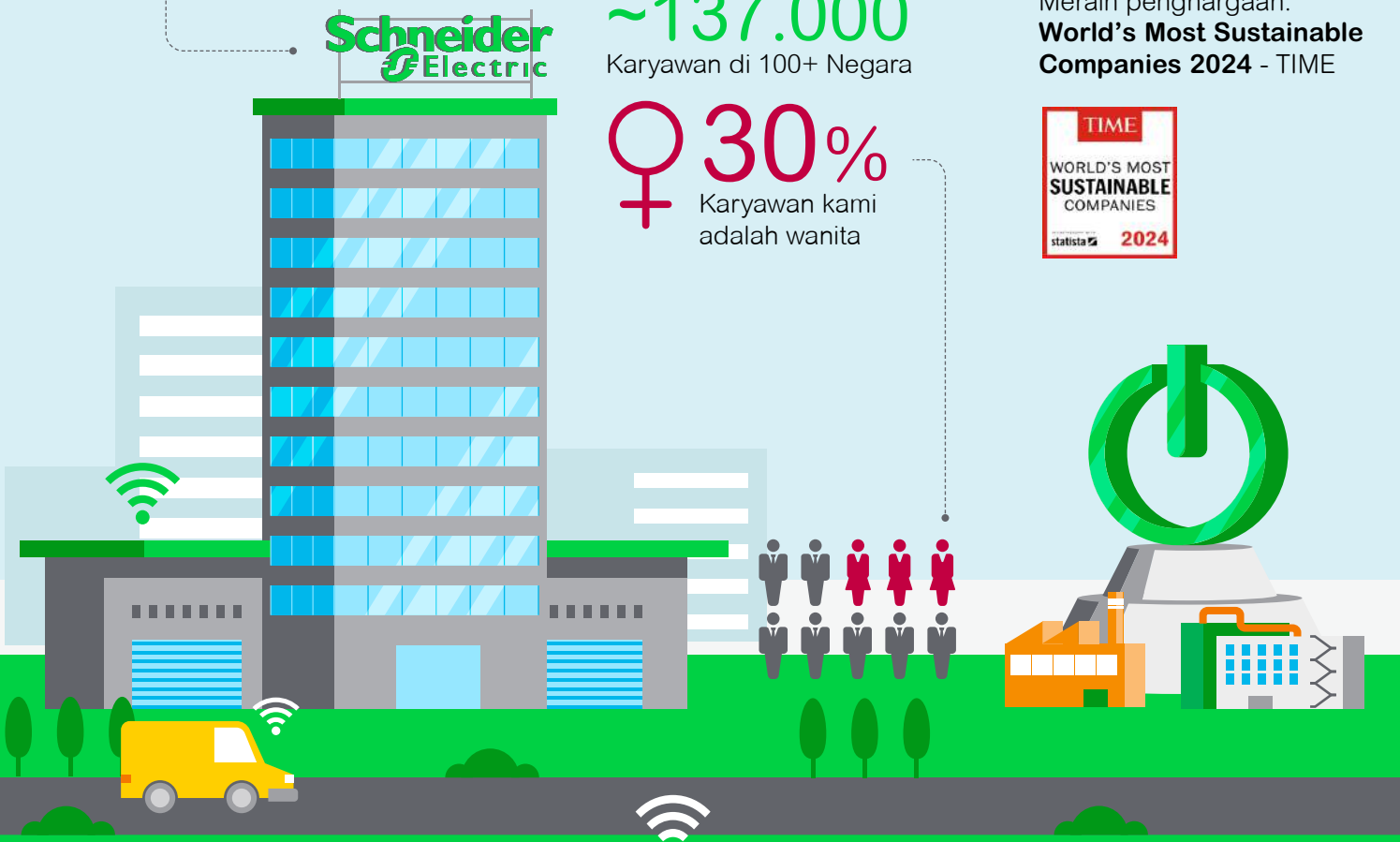

Infrastruktur

Menciptakan jaringan distribusi di seluruh Indonesia

4 Bisnis yang Terintegrasi & Sinergis

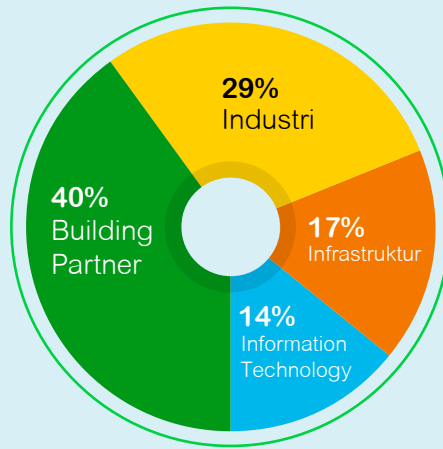

5%

dari Pendapatan disalurkan untuk Riset & Pengembangan

45%

Pendapatan dari IoT

42%

Pendapatan dari Ekonomi Baru

Sebagai **pemimpin global di transformasi digital** untuk manajemen energi dan otomasi, kami menciptakan teknologi terhubung yang



Membentuk Kembali Industri



Memperkaya Hidup



Mengubah Perkotaan

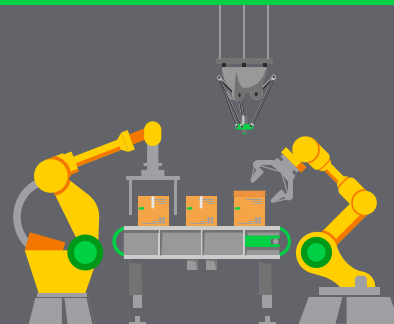

€26 Miliar
Pendapatan 2018

€3.9 Miliar
EBITDA yang disesuaikan 2018



Yang Asli # Yang Melindungi

Sebagai perusahaan yang senantiasa mengutamakan keselamatan dan keamanan pengguna, PT Schneider Indonesia berkomitmen memastikan setiap produk yang dipasarkan memenuhi standar kualitas tinggi serta mematuhi peraturan yang berlaku di Indonesia.

Kenali resiko menggunakan produk palsu dan langkah-langkah untuk mengidentifikasi produk asli.



Domae MCBs

⚠ Risiko Menggunakan Produk Palsu ⚠

- Gagal memutuskan selama kondisi overcurrent atau short-circuit yang dapat menyebabkan kerusakan kabel atau kebakaran
- Trip lebih awal akibat kalibrasi yang buruk (misalnya, MCB 10 A trip pada arus yang jauh di bawah 10 A) yang mengarah pada pemadaman listrik
- Pemanasan berlebih akibat kehilangan energi yang tinggi, menyebabkan produk terbakar atau meleleh

Mengidentifikasi Produk Asli



- 1 Periksa logo SNI yang seharusnya dicetak laser di bagian atas MCB, di atas toggle.



- 2 Pastikan tahun dan minggu produksi yang sama tertera di bagian atas dan depan MCB



TeSys Deca Contactors Domae

⚠ Risiko Menggunakan Produk Palsu ⚠

- Risiko kegagalan kontraktor yang dapat menyebabkan kebakaran pada panel kontrol, motor, mesin, dll.
- Umur produk yang pendek disebabkan oleh kualitas pembuatan yang buruk, mengakibatkan kurangnya daya tahan.
- Waktu henti saat produksi di pabrik.

Mengidentifikasi Produk Asli

Pindai kode QR dengan perangkat Anda dan pastikan bahwa nomor seri unik yang ditampilkan di situs resmi go2se.com cocok dengan yang tercetak pada produk. Proses identifikasi ini berlaku untuk produk yang **diproduksi sejak tahun 2021**.





EasyPact EZC MCCBs



Risiko Menggunakan Produk Palsu



- Bahaya percikan busur listrik akibat ketidakmampuan MCCB untuk memutus sirkuit saat terjadi hubungan singkat, yang dapat menyebabkan cedera bakar atau bahkan kehilangan nyawa.
- Pemanasan panel listrik dan kegagalan sambungan busbar akibat suhu yang berlebihan.

Mengidentifikasi Produk Asli

Tanggal produksi mulai dari 27 November 2023 untuk EZC100, 11 Maret 2024 untuk EZC250, dan 1 Juni 2024 untuk EZC400-630.

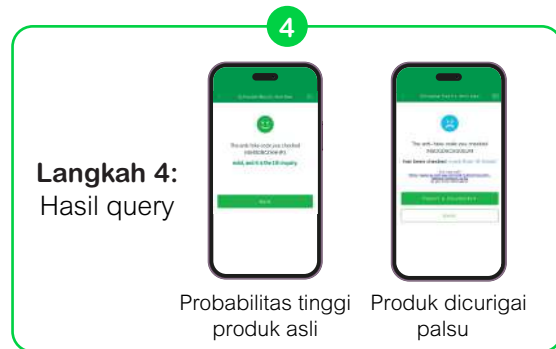
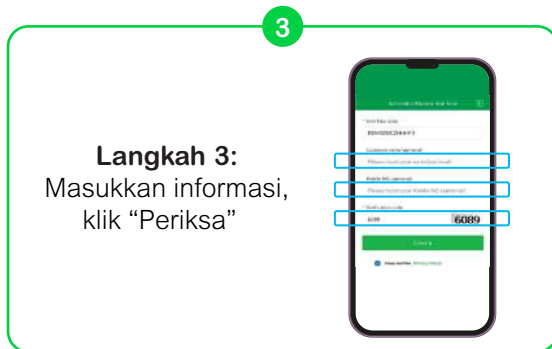
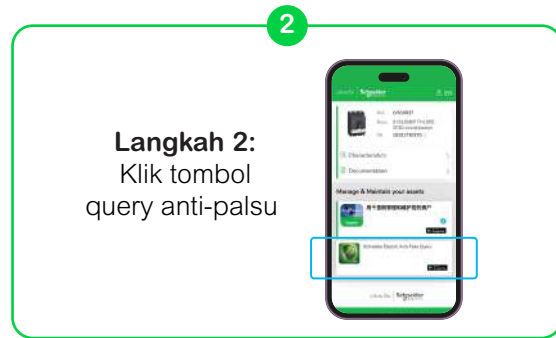
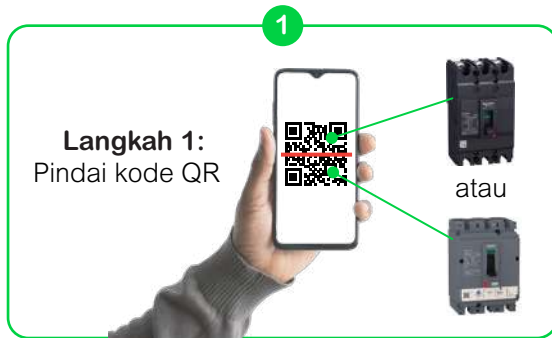

Waspada

Barang yang tidak berlisensi dan barang palsu tidak hanya ilegal, tetapi juga berbahaya. Meskipun produk tiruan mungkin memiliki logo atau merek dagang Schneider Electric, produk tersebut tidak dibuat sesuai dengan spesifikasi dan standar Schneider Electric.

Jika Anda memiliki pertanyaan atau ingin melaporkan masalah pada produk Schneider Electric yang Anda miliki, jangan ragu untuk menghubungi:

CCC:
1500055

Email:
customercare.id@se.com

Informasi lebih lanjut:
se.com/id/id/work/support/counterfeit/

Ingat, utamakan keselamatan dengan menggunakan produk asli, karena hanya
#YangAsliYangMelindungi

Daftar Isi

Infografik 02

Yang Asli Yang Melindungi 04

Daftar isi 06

AvatarON 08



Sakelar dengan personalisasi cover

Leona 11 USB Charger 14



Sakelar Untuk Semua rumah



Vivace, Pieno, ZENcelo, & AvatarON

ZENcelo 16



Sakelar dan kontak datar pertama di dunia

Pieno 19



Vivace 22 S-Classic 24



Sakelar Minimalis dan Modern



Desain Tak Lekang Waktu

Kavacha 26 Argus 30



Perlindungan Sepanjang Waktu



Occupancy Sensor

Domae 32



Pastikan rumah Anda terlindungi oleh perangkat proteksi arus listrik yang berkualitas

Easy9

38



MCB dan RCCB untuk rumah tinggal dengan kualitas terpercaya

GoPact MCCB

42



Robust, Simple, Compact, Standalone

GoPact MTS

53



Sakelar Transfer Manual

TransferPacT Active Automatic

56



Siap memberikan waktu operasional maksimal



Industrial Plug Socket

59

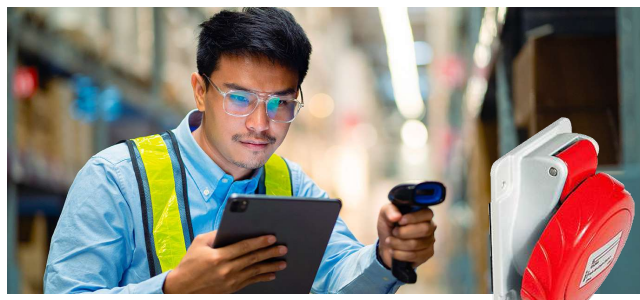

Performa tinggi sesuai dengan standar IEC serta mudah diinstal

Easy TeSys

61

Tesys Deca

64



Kontaktor dengan kemampuan beroperasi 1,4 juta kali



Solusi starter motor inovatif dan terkoneksi

Easy Logic

70

Harmony Push Button & Signaling

73



Power Meter yang Lengkap dan Andal



Push Button tahan hingga 10 juta kali klik

UPS

76



Melindungi perangkat elektronik Anda dari gangguan listrik

Life Is On

Schneider
Electric

AvatarON

Sakelar dengan
personalisasi cover



Inovasi Desain dan Teknologi

Pada 2017, AvatarON mendapatkan penghargaan Desain iF yang bergengsi, salah satu dari keunggulan desain, kualitas, dan kepercayaan desain yang paling diakui dan diakui dunia.

Dengan SS Mechanism Switch, sudut sakelar hanya 3 derajat, menghasilkan suara yang halus dan mengurangi resiko terjadinya loncatan api listrik.

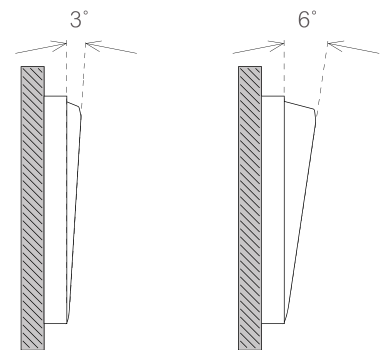

SS Mechanism

Rocker konvensional



Innovative
Interchangeable
Cover



AvatarON

Bahan baku premium, kualitas terbaik, dan ramah lingkungan



Jenis	No. Gambar	Keterangan	Referensi	WE*		WG*		DG*		WD*	
				Harga (Rp) <small>(Sebelum PPN)</small>	SS	Harga (Rp) <small>(Sebelum PPN)</small>	SS	Harga (Rp) <small>(Sebelum PPN)</small>	SS	Harga (Rp) <small>(Sebelum PPN)</small>	SS
Sakelar Horizontal	1	16AX 250V 1G 1W Sw w LED,	E8331L1LED_**_G3	95.700	1	124.500	1	124.500	1	162.500	1
		16AX 250V 1G 2W Sw w LED,	E8331L2LED_**_G3	121.400	1	140.700	1	140.700	1	-	-
	2	16AX 250V 2G 1W Sw w LED,	E8332L1LED_**_G3	136.400	1	170.700	1	170.700	1	222.600	1
		16AX 250V 2G 2W Sw w LED,	E8332L2LED_**_G3	184.800	1	213.200	1	213.200	1	245.900	2
	3	16AX 250V 3G 1W Sw w LED,	E8333L1LED_**_G3	188.100	1	217.200	1	217.200	1	282.800	1
		16AX 250V 3G 2W Sw w LED,	E8333L2LED_**_G3	214.400	2	247.700	2	250.100	1	-	-
4	16AX 250V 4G 1W Sw w LED,	E8334L1LED_**_G3	205.400	1	236.300	1	236.300	1	341.400	1	
	16AX 250V 4G 2W Sw w LED,	E8334L2LED_**_G3	-	-	266.500	2	266.500	2	-	-	
Sakelar Bel	5	10A 250V 1G BP Sw	E8331BPL1_**_G3	-	-	-	-	269.300	2	-	-
Dimmer	6	1G 250VA Dimmer w Sw	E8331RD250_**	546.200	1	710.300	1	710.300	1	914.200	2
Stop Kontak	7	16A Schuko Socket	E83426_16S_**_G3	123.100	1	141.600	1	141.600	1	163.400	1
	8	16A250V1Gang international Skt	E83426TS_**	235.800	2	385.700	2	385.700	2	502.200	2
	9	13A 250V 1G SW Skt w LED	E8315N_**	152.600	1	186.200	1	186.200	1	208.500	2
Stop Kontak Data, TV, Telp	10	1G TV Socket 75Ohm Through-Connect	E8331TV_**	122.500	1	159.900	1	159.900	1	184.500	1
		1G TEL Socket Shuttered Wallplate	E8331RJS4_**	121.300	1	158.500	1	158.500	1	181.400	2
		1G RJ45 Data CAT5E Shuttered	E8331RJS5_**	123.500	2	161.300	2	161.300	2	184.000	2
		1G RJ45 Data CAT6 Shuttered	E8331RJS6_**	125.800	1	163.900	1	163.900	1	186.800	2
Stop Kontak HDMI	12	HDMI + USB SOCKET (Media)	E8332HDUSB_**	491.700	2	673.000	2	673.000	2	-	-
	13	2G HDMI + HDMI KEYSTONE	E8332HDHD_**	633.100	2	-	-	-	-	-	-
Usb Charger	14	16A Int Socket with 2.1A USB	E8342616USB_**	614.600	1	706.800	1	706.800	1	811.700	2
	15	2 x 2.1A USB Charger	E8332USB_**	1.022.700	2	1.250.300	2	1.250.300	2	1.424.500	2
	16	21W Type A+C, PD+QC3.0 USB Charger	E8332ACQUSB_**	1.227.600	2	1.414.900	2	-	-	1.838.700	2
Aksesori Hotel	17	DND, PCU, PW Ind w Bell SW	E8331BPMW_**	263.800	2	-	-	307.400	2	-	-
	18	16AX 3G Sw with PCU, DND, PW Sym	E8333DMWS_**	270.600	2	-	-	-	-	-	-
	19	250V 16A Elec Keycard SW w ID	E8331EKTID_**	-	-	-	-	1.758.700	2	-	-
		250V 16A Elec Keycard SW	E8331EKT_**	775.100	2	834.700	2	834.700	2	950.800	2
20	115/240V 20VA Uni Ver Shaver	E83T727V_**	939.800	2	1.081.000	2	1.081.000	2	1.232.600	2	
Blank Plate & Switch Cover	21	1G Blank Plate	E8330X_**	47.200	2	54.800	2	54.800	2	94.800	2
		1G Sw Cover	E8331_**	48.700	2	71.100	2	-	-	136.700	2
	22	1G Sw Cover w Keyholder	E8331KH_**	59.600	2	-	-	-	-	-	-
	23	2G Sw Cover	E8332_**	59.600	2	74.500	2	-	-	177.500	2
	24	3G Sw Cover	E8333_**	65.100	2	94.400	2	-	-	-	-
25	4G Sw Cover	E8334_**	71.100	2	86.400	2	86.400	2	243.500	2	
Frame	26	2G Bracket	E8331_26_**	45.600	2	72.900	2	72.900	1	108.500	2
	27	3G Bracket	E8331_36_**	56.900	2	81.200	2	82.000	1	-	-
	28	4G Bracket	E8331_46_**	68.400	2	94.800	2	94.800	2	-	-
	29	5G Bracket	E8331_56_**	-	-	-	-	115.600	2	-	-



SS (Status Stock) : 1 (Stock) / 2 (Indent)

Kualitas Material Superior



Berbahan baku kualitas tinggi dengan proteksi anti UV sehingga warna terlindungi, tahan lama serta tidak berubah warna seiring dengan berjalannya waktu



Menggunakan material Bayer PC (*Polycarbonate*) yang tahan banting, tahan panas, tidak merambatkan api serta anti karat



Pengamanan tambahan: memastikan kualitas operasional



Material dengan standar CCC, BS dan SNI, serta telah memenuhi Pedoman Pembatasan Bahan Berbahaya (RoHS)



Pemasangan serta peroperasian mudah



Bahan Baku Premium, kualitas terbaik dan **ramah lingkungan**



Life Is On

Schneider
Electric

Leona

Sakelar untuk semua rumah



Performa maksimal untuk rumah Anda

- Frame modul terbuat dari logam, menjamin kualitas, kekuatan, dan tahan lama
- Cakar terlindungi, menjamin kekuatan dan daya cengkram pada inbowdoost, sehingga bertahan lebih lama
- Modul terbuat dari *Polycarbonate* berkualitas, lebih aman karena lebih tahan panas



Dua cara pemasangan mudah, sistem pencakar atau sekrup



Konstruksi mekanikal kuat dan tahan lama



Desain stylish dan minimalis

Dua Cara Pemasangan

Menggunakan 2 pilihan cara pemasangan, dengan sistem pencakar atau sekrup

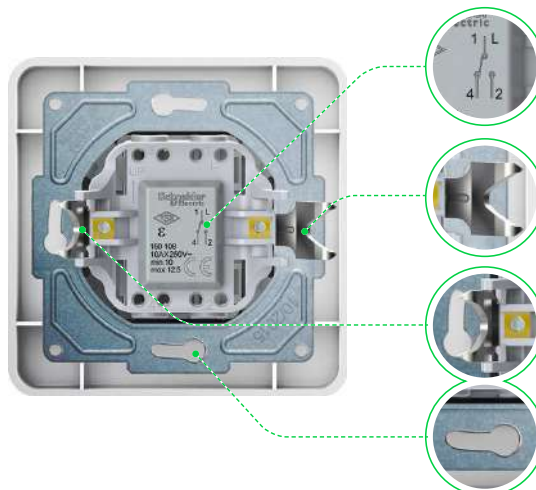

Instruksi lengkap

Diagram perkabelan tercetak di bagian dalam produk

Cakar penahan yang kuat

bagian pencakar yang optimal untuk pemasangan yang kuat

Pemasangan yang mudah

Disesuaikan dengan kebutuhan Anda. Pemasangan bisa dilakukan dengan sistem sekrup dan pencakar

Leona

Keterangan	Referensi	Pak	Harga (Rp) <i>(Sebelum PPN)</i>
Sakelar			
10AX Sakelar 1 Gang - 1 Arah	LNA0100321	10	20.100
10AX Sakelar 1 Gang - 2 Arah	LNA0400321	10	25.800
10AX Sakelar 2 Gang - 1 Arah	LNA0300321	10	24.600
10AX Sakelar 2 Gang - 2 Arah	LNA0600321	10	37.900
10AX Sakelar 3 Gang - 1 Arah	LNA2100321	10	41.600
10AX Sakelar Perantara (Intermediate)	LNA0500321	10	67.100
16AX 1 Gang Sakelar Bel dengan indikator	LNA0800321	10	42.000
Stop Kontak			
16A 1 Gang Kotak Kontak Tipe Schuko tanpa Child Protection	LNA2900121	10	20.100
16A 1 Gang Kotak Kontak Tipe Schuko dengan Child Protection	LNA2900221	10	24.600
2 GANG SCHUKO CP	LNA9100221	6	55.900
Frame Double dengan 1 Schuko CP + Kosong	LNA9000221	9	32.700
Frame Triple dengan 1 Schuko CP + 2 Kosong	LNA9200221	7	35.300
Stop Kontak, Data, TV, Telepon			
Stop Kontak TV	LNA3200121	10	53.200
Stop Kontak Telepon	LNA4100121	10	55.400
Stop Kontak Data RJ45 Cat 5	LNA4300121	10	70.500
Stop Kontak Data RJ45 Cat 6	LNA4700121	10	87.400
Aksesori Hotel & Lainnya			
Energy Saver Card Hotel	LNA1900221	8	225.700
2 Gang USB Charger Max 2.1a	LNA4500121	10	282.000
2 Gang Universal Frame	LNA5800221	25	10.000
3 Gang Universal Frame	LNA5800321	15	12.600
1 Gang Outbow Leona	OBL838348	-	12.000

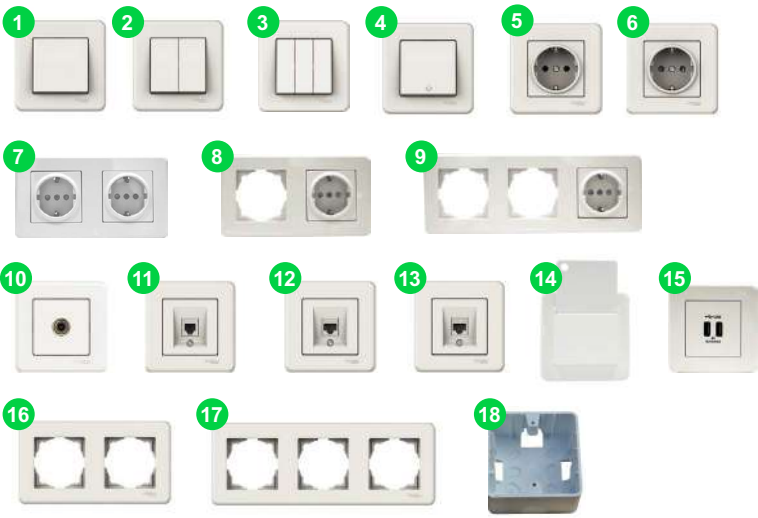

Box, Aksesori dan Floor Socket



- Tersedia dalam 2 pilihan material Aluminium dan Kuningan (Brass)
- Berbagai pilihan dan kombinasi modul, termasuk untuk telekomunikasi
- Dilengkapi dengan Floor Box
- Daya tahan tinggi
- Konstruksi kuat
- IP44

Keterangan	Referensi	Pak	Harga (Rp) (Sebelum PPN)
1 Gang Outbow Leona	OBL838348	1	12.000
Wall Box, Black	SWB_727245	1	4.300
Mounting Box W/O Term	E238	1	30.400
2 Gang Surface Mount Polycarb Wallbox	E238_2	1	70.400
2 Gang DP Mount'g Box	ET238D	1	82.400
Floor Socket			
Empty Floor Skt W/ Box, IP44, DPG, Silver Color	E227F_ABE	1	597.200
Empty Floor Skt W/ Box, IP44, DPG, Brass Color	E227F_BAS	1	680.900
S-Flexi			
Universal Socket 3 Pin 13A, 250V, Size M	F1426UAM	32	47.300
Universal Socket 2 Pin 10 A, 250 V, Size M	F1426USM	32	59.900
Universal Socket 2 Pin 10 A, 250 V Size S	F30426USM	30	37.400
TV Koaksial Socket	F50TVM	30	55.105
TV Koaksial Socket	F30TVSM_WE	30	123.900
4PIN RJ11 TEL Socket, Tanpa Penutup	F30R4M	30	67.500
CAT5E Data Communication, Tanpa Penutup	F30RJ5EM	30	90.200

Dimensi:

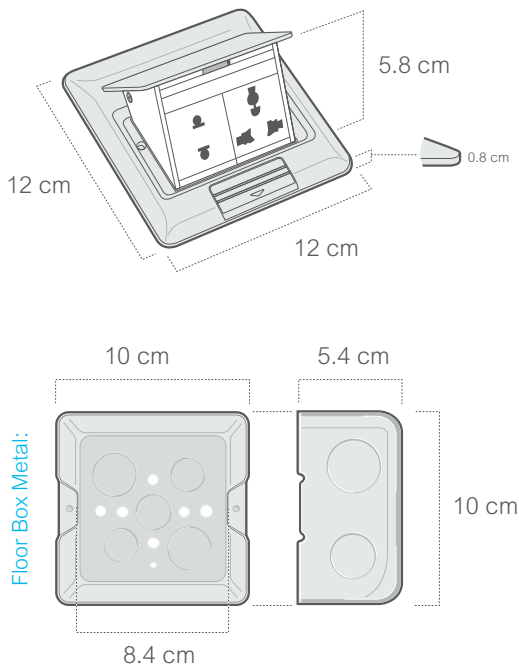

USB Charger Range

Vivace, Pieno, Zencelo, AvatarOn



Proses Charging Cepat

Output 2.1A per outlet, 2 Gang USB max 4.2A.
Tersedia Quick charge Type A + C QC - 21 W Max

Energy Efficiency

Fitur keamanan dan perlindungan memastikan pengisian daya ke gadget Anda aman & Efisien

Fitur Perlindungan



Perlindungan terhadap panas berlebih



Perlindungan terhadap arus tidak stabil



Perlindungan terhadap tegangan tidak stabil

Charger USB Type A + C



- Soket USB pertama dan satu-satunya yang terdaftar di Qualcomm "Wall-mounted QC USB" (Qualcomm Quick Charge Technology Device List version 03/2019)
- Ketika Soket Type A telah selesai mengisi ulang daya, soket Type C akan secara otomatis mengubah isi ulang daya menjadi "Fast Charge" (Schneider Electric patented).
- Type A or Type C alone, 5V 3A, 9V 2A, 12V 1.5A
- Type A and Type C, 5V 2.4A Max for every port

USB Charger Type A Warna Putih (Body Putih, LED Putih)



2.1 A Fast charging setiap Modulnya

Jenis	Gambar	Family - Warna	Referensi	Harga (Sebelum PPN)
1 Gang USB Chargers 2.1A		Vivace	KB31USB_WE	417.600
		Pieno, Putih	E8231USB_WE	519.000
		Zencelo, Silver Bronze	E8431USB_SZ	725.000
2 Gang USB Chargers 2 x 2.1A		Vivace	KB32USB_WE	869.400
		Pieno, Putih	E8232USB_WE	1.028.600
		Pieno, Lavender Silver	E8232USB_LS	1.104.900
		Zencelo, Silver Bronze	E8432USB_SZ	1.352.000
		AvatarON, Putih	E8332USB_WE	1.022.700
		AvatarON, Wine Gold	E8332USB_WG	1.250.300
		AvatarON, Dark Grey	E8332USB_DG	1.250.300
AvatarON, Dark Wood	E8332USB_WD	1.424.500		

International Socket + 2.1 A USB

Jenis	Gambar	Family - Warna	Referensi	Harga (Sebelum PPN)
International Socket + 2.1 A USB		Vivace	KB42616USB_WE	500.500
		Pieno, Putih	E8242616USB_WE	546.600
		Pieno, Lavender Silver	E8242616USB_LS	615.000
		AvatarOn, Putih	E8342616USB_WE	614.600
		AvatarOn, Wine Gold	E8342616USB_WG	706.800
		AvatarOn, Dark Grey	E8342616USB_DG	706.800
		AvatarOn, Dark Wood	E8342616USB_WD	811.700

Type A + C QC - 21 W Max

Jenis	Gambar	Family - Warna	Referensi	Harga (Sebelum PPN)
Type A + C QC - 21 W Max		Vivace	KB32ACQUSB_WE	877.000
		AvatarOn, Putih	E8332ACQUSB_WE	1.227.600
		AvatarOn, Wine Gold	E8332ACQUSB_WG	1.414.900
		AvatarOn, Dark Wood	E8332ACQUSB_WD	1.838.700

Life Is On

Schneider
Electric

ZENcelo

Sakelar dan kotak kontak datar pertama di dunia



Sakelar datar pertamadi dunia

























- Mekanisme 'impress' (iso-motion-press) yang telah dipatenkan memastikan bingkai sakelar tetap statis, baik ketika dalam posisi 'ON' atau 'OFF'
- Sakelar diuji sebanyak 80.000 kali (2 kali lebih banyak dari standar internasional)

impress

Kualitas & Keamanan yang Dirancang Tahan Lama

- Setiap bagian dilindungi oleh lapisan *polyurethane* untuk menjamin reabilitas produk.
- Terbuat dari material *polycarbonate* tahan **karat, panas, serta benturan**



Jenis	Gambar	Keterangan	Referensi	Pak	Harga (Sebelum PPN)
SAKELAR		16AX Sakelar Datar 1 Gang 1 Arah dengan Indikator, Silver Bronze	E8431_1_SZ_G3	8	127.400
		16AX Sakelar Datar 1 Gang 2 Arah, Silver Bronze	E8431_2_SZ_G3	8	177.900
		16AX Sakelar Datar 2 Gang 1 Arah dengan Indikator, Silver Bronze	E8432_1_SZ_G3	8	170.700
		16AX Sakelar Datar 2 Gang 2 Arah, Silver Bronze	E8432_2_SZ_G3	8	228.500
		16AX Sakelar Datar 3 Gang 1 Arah dengan Indikator, Silver Bronze	E8433_1_SZ_G3	8	242.700
		16AX 4 Gang 1 Arah Sakelar Datar dengan Indikator, Silver Bronze	E8434_1_SZ_G3	8	282.200
		20A 1 Gang Sakelar Ganda Datar Neon, Silver Bronze	E8431D20_SZ	8	208.700
		10A Sakelar Bel Datar, Silver Bronze	E8431BP1_SZ	10	456.400
KOTAK KONTAK		16A 1 Gang Kotak Kontak Tipe Schuko, Silver Bronze	E84426_16S_SZ_G3	6	153.400
		16A 2 Gang Kotak Kontak Tipe Schuko, Silver Bronze	E84T426_16S_SZ_G3	4	182.500
		16A 1 Gang Kotak Kontak Internasional, Silver Bronze	E8442616TS_C15426B	8	211.900
		13A 1 Gang Kotak Kontak dengan Sakelar, Neon, Silver Bronze	E8415N_SZ	8	265.700
USB CHARGER		1 x 2.1A USB Charger, SZ	E8431USB_SZ	8	725.000
		2 x 2.1A USB Charger, SZ	E8432USB_SZ	8	1.352.000
PLAT PENUTUP		1 Gang Plat Penutup, Silver Bronze	E8430X_SZ	12	65.500
FRAME GRID PLATE		Frame Tepi Reguler dengan konektor	E8403_36S_SZ	16	63.300
KOTAK KONTAK TV, TELEPON DAN DATA		1 Gang Kotak Kontak Soket TV, Master, Silver Bronze	E8431TVM_SZ	8	371.700
		1 Gang Kotak Kontak RJ11 4 Kawat Telepon Dengan Penutup, Silver Bronze	E8431RJS4_SZ	8	217.500
		1 Gang Kotak Kontak RJ45 Data Outlet Cat 5E, Silver Bronze	E8431RJ_5_SZ	8	475.900
		1 Gang Kotak Kontak RJ45 Data Outlet Cat 6, Silver Bronze	E8431RJ_6_SZ	8	431.300
AKSESORI HOTEL		Electronic Key Card Time Delay SW	E8431EKT_SZ	6	1.075.700
		2G Full-Flat SW w/DND & PCU Symbols	E8432DMS_SZ	8	380.900
		1G Full-Flat Bell SW w/DND & PCU Symbols	E8431BPDM_SZ	8	367.300
		Universal Shaver Unit, Vertical	E84T727V_SZ	1	1.200.900

Jenis	Gambar	Keterangan	Referensi	Pak	Harga (Sebelum PPN)
SAKELAR		16AX Sakelar Datar 1 Gang 1 Arah dengan Indikator, Putih	E8431_1_WE_G3	8	69.600
		16AX Sakelar Datar 1 Gang 2 Arah, Putih	E8431_2_WE_G3	8	121.900
		16AX Sakelar Datar 2 Gang 1 Arah dengan Indikator, Putih	E8432_1_WE_G3	8	110.100
		16AX Sakelar Datar 2 Gang 2 Arah, Putih	E8432_2_WE_G3	8	184.300
		16AX Sakelar Datar 3 Gang 1 Arah dengan Indikator, Putih	E8433_1_WE_G3	8	195.100
		16AX Sakelar Datar 3 Gang 2 Arah , Putih	E8433_2_WE_G3	8	299.900
		16AX 4 Gang 1 Arah Sakelar Datar dengan Indikator, Putih	E8434_1_WE_G3	8	246.100
KOTAK KONTAK		16A 1 Gang Kotak Kontak Tipe Schuko, Putih	E84426_16S_WE_G3	6	84.700
		16A 2 Gang Kotak Kontak Tipe Schuko, Putih	E84T426_16S_WE_G3	4	133.000
		16A 1 Gang Kotak Kontak Internasional, Putih	E84426_16TS_C15426	8	180.200
KOTAK KONTAK TV, TELEPON DAN DATA		13A 1 Gang Kotak Kontak dengan Sakelar, Neon, Putih	E8415N_WE_G11	8	232.000
		1 Gang Kotak Kontak Soket TV, Master, Putih	E8431TVM_WE	8	292.900
		1 Gang Kotak Kontak RJ45 Data Outlet Cat 6, Putih	E8431RJ_6_WE	8	412.000



Life Is On

Schneider
Electric

Pieno

Kombinasi sempurna antara estetika dan performa



SS Mechanism Switch

Sudut sakelar hanya 3 derajat, menghasilkan suara yang halus dan mengurangi resiko terjadinya loncatan api listrik.

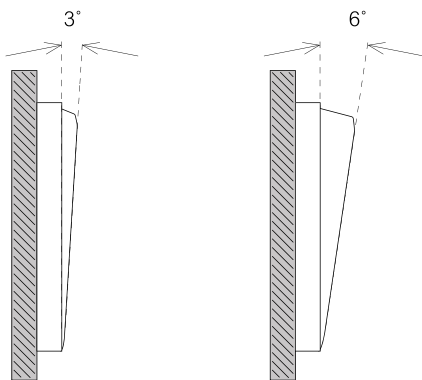

SS Mechanism

Rocker konvensional



PerfectFace
SWITCH ARCHITECTURE

















PerfectFace® Switch Architecture

Penutup permukaan sakelar yang berguna untuk menjaga tampilan produk tetap sempurna saat proses pengecatan dinding.

Jenis	Gambar	Keterangan	Referensi	Pak	Harga (Sebelum PPN)
SAKELAR		16AX 250V Sakelar 1 Gang 1 Arah, Fluoresen, Putih	E8231L1F_WE_G3	8	54.200
		16AX 250V Sakelar 1 Gang 2 Arah, Fluoresen, Putih	E8231L2F_WE_G3	8	58.600
		16AX 250V Sakelar 2 Gang 1 Arah, Fluoresen, Putih	E8232L1F_WE_G3	8	86.000
		16AX 250V Sakelar 2 Gang 2 Arah, Fluoresen, Putih	E8232L2F_WE_G3	8	93.800
		16AX 250V Sakelar 3 Gang 1 Arah, Fluoresen, Putih	E8233L1F_WE_G3	6	150.800
		16AX 250V Sakelar 3 Gang 2 Arah, Fluoresen, Putih	E8233L2F_WE_G3	6	156.300
		10AX 250V Sakelar 4 Gang 1 Arah, Fluoresen, Putih	E8234L1F_WE_G3	6	171.700
		16AX 250V Sakelar 4 Gang 2 Arah, Fluoresen, Putih	E8234L2F_WE_G3	6	170.900
		16AX 250V Sakelar 1 Gang Sakelar Intermediate, Putih	E8231MF_WE_G3	6	139.600
		10A 250V 1 Gang Sakelar Momentary, Fluoresen, Putih	E8231PRL1F_WE_G3	8	59.200
KOTAK KONTAK		16A 250V 1 Gang Kotak Kontak Tipe Schuko, Putih	E82426_16S_WE_G3	8	74.500
		13A 250V Gang Kotak Kontak dan Sakelar, Neon, Putih	E8215N_WE_G1	8	126.400
USB CHARGER		1 x 2.1A USB Charger, WE	E8231USB_WE	8	519.000
		2 x 2.1A USB Charger, WE	E8232USB_WE	8	1.028.600
		16A International Socket + 2.1 A USB	E8242616USB_WE	8	546.600
PLAT PENUTUP		1 Gang Plat Penutup, Putih	E8230X_WE_G1	10	34.600
		1 Gang Kotak Kontak TV Soket, 75 Ohm, Putih	E8231TV_WE	8	139.500
KOTAK KONTAK TV, TELEPON DAN DATA		1G TELEPHONE SKT, KS ON ST WALLPLATE	E8231RJS4_WE	8	143.000
		1G RJ45 DATA, CAT5E, KS ON SHU WP	E8231RJS_5_WE	8	125.800
		240V 450W UNI DIMMER WITH SW	E8232RD450U_WE_G1	8	810.600
PEREDUP LAMPU		250V 16A ELEC KEY CARD TIME DE	E8231EKT_WE_G1	6	719.100
AKSESORI HOTEL		250V 16A ELEC KEY CARD TIME DE	E8231EKT_WE_G1	6	719.100



Desain bagian belakang sakelar dirancang berbentuk lingkaran untuk memudahkan pemasangan pada dinding kayu dan furnitur

Jenis	Gambar	Keterangan	Referensi	Pak	Harga (Sebelum PPN)
SAKELAR		16AX 250V Sakelar 1 Gang 1 Arah, Fluoresen, Lavender Silver	E8231L1F_LS_G3	8	103.200
		16AX 250V Sakelar 1 Gang 2 Arah, Fluoresen, Lavender Silver	E8231L2F_LS_G3	8	140.600
		16AX 250V Sakelar 2 Gang 1 Arah, Fluoresen, Lavender Silver	E8232L1F_LS_G3	8	116.200
		16AX 250V Sakelar 2 Gang 2 Arah, Fluoresen, Lavender Silver	E8232L2F_LS_G3	8	197.000
		16AX 250V Sakelar 3 Gang 1 Arah, Fluoresen, Lavender Silver	E8233L1F_LS_G3	6	208.500
		16AX 250V Sakelar 3 Gang 2 Arah, Fluoresen, Lavender Silver	E8233L2F_LS_G3	6	262.900
		10AX 250V Sakelar 4 Gang 1 Arah, Fluoresen, Lavender Silver	E8234L1F_LS_G3	6	218.600
		16AX 250V Sakelar 4 Gang 2 Arah, Fluoresen, Lavender Silver	E8234L2F_LS_G3	6	246.500
KOTAK KONTAK		16A 250V 1 Gang Kotak Kontak Tipe Schuko, Lavender Silver	E82426_16S_LS_G3	8	121.900
		13A 250V 1 Gang Kotak Kontak dan Sakelar, Neon, Lavender Silver	E8215N_LS_G1	8	183.300
USB CHARGER		2 x 2.1A USB Charger, Lavender Silver	E8232USB_LS	8	1.104.900
		16A Int Socket with 2.1A USB, Lavender Silver	E8242616USB_LS	8	615.000
KOTAK KONTAK TV, TELEPON DAN DATA		1 Gang Kotak Kontak, 75OHM, THROUGH-CNN	E8231TV_LS_G1	8	161.900
		1G TEL SKT, KS ON SHU WP	E8231RJS4_LS_G1	8	233.000
		1G RJ45 DATA, CAT5E, KS ON SHU WP	E8231RJS_5_LS_G1	8	203.700

Kombinasi sempurna antara estetika dan performa



Life Is On

Schneider
Electric



Vivace

Sakelar Minimalis & Modern



*) Dahulu dikenal dengan merek Clipsal. Clipsal telah diakuisisi oleh Schneider Electric di tahun 2007

Jenis	Referensi	Keterangan	No. Gambar	Harga (Rp) (Sebelum PPN)	SS
Sakelar	KB31_1_WE_G3	16AX 250V 1 Gang - 1 Arah	1	31.800	1
	KB31_WE_G3	16AX 250V 1 Gang - 2 Arah	1	40.400	1
	KB32_1_WE_G3	10A 250V 2 Gang - 1 Arah	2	49.800	1
	KB32_WE_G3	10A 250V 2 Gang - 2 Arah	2	63.100	1
	KB33_1_WE_G3	16AX 250V 3 Gang - 1 Arah	3	74.200	1
	KB33_WE_G3	16AX 250V 3 Gang - 2 Arah	3	79.500	2
	KB34S_1_WE_G3	10AX 250V 4 Gang - 1 Arah, WE	4	118.800	1
	KB31IA_WE	10AX 250V Sakelar Intermediate	5	111.800	2
Sakelar Ganda	KB31BPB	10A 250V 1 Gang Sakelar Bell	5	115.500	2
	KB31D20NE_WE	20A 250V Double Pole Switch W Neon+Earth	6	90.300	2
Stop Kontak	KB426_16S_WE_G3	16A 1 Gang Kotak Kontak Tipe Schuko	7	47.500	1
	KB15N	13A 250V 1 Gang Kotak Kontak Sakelar Neon	8	98.300	1
	KB413S_C15329	13A 250V 1 Gang Kotak Kontak Universal 3 pin SKT_C15329	9	61.500	2
USB Charger	KB31USB_WE	1 x 2.1A USB Charger, WE	10	417.600	2
	KB32USB_WE	2 x 2.1A USB Charger, WE	11	869.400	2
	KB42616USB_WE	16A Int Socket with 2.1A USB, WE	12	500.500	2
	KB32ACQUSB_WE	21W Type A+C, PD+QC3.0 USB Charger, WE	13	877.000	2
Plat Penutup	KB30_WE	1 Gang Plat Penutup	14	30.300	2
Aksesori Bingkai	KB_21_WE	KB 2 Gang Surround With Schneider Brand	15	22.900	2
	KB_31_WE	KB 3 Gang Surround With Schneider Brand	16	27.000	2
Kotak Kontak Tv, Telepon Dan Data	KB31TS_WE	1 Gang Telepon Outlet Dengan Penutup	17	122.600	1
	KB32TS	2 Gang Telepon Outlet Dengan Penutup	18	111.700	1
	KB31TV-OS	1 Gang Kotak Kontak TV	19	118.700	1
	KB31RJ5E_WE	1 Gang Kotak Kontak Data Cat 5E Dengan Penutup	20	125.000	1
	KB31RJ6_WE	1 Gang Kotak Kontak Data Cat 6	21	159.000	1
	KB32TS_RJ5E	1 Gang Telp dengan penutup dan 1 Gang Data Cat 5E	22	222.700	2
Peredup Lampu	KB31RD250T_WE	10A, 240VAC Dimer, Light Control, Rotary	23	341.300	2
Fan Control	KB31RF250_WE	250VA 3 Gang Pengatur Kecepatan Kipas (Exhaust)	24	650.000	2
	KB31EKT	Hotel Key Card	25	692.800	2
Aksesori Hotel	KB31BD_C_WE	Do Not Disturb & Clean Up Room dengan Bell Press	26	165.300	2
	KBT727V_WE	115/240V Shaver Unit	27	757.500	2

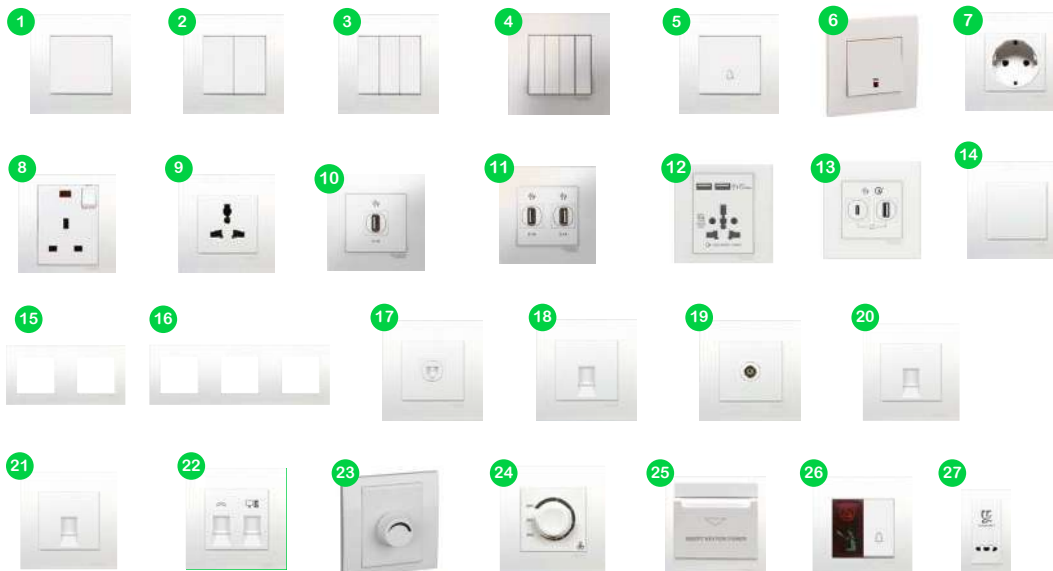

Life Is On

Schneider
Electric



S-Classic

Desain Tak Lekang Waktu

- Dipercaya lebih dari 40 tahun
- Kuat dan tahan banting

Clipsal telah diakuisisi oleh
Schneider Electric di tahun 2007



SNI

housing
estate
award
2016

housing
estate
award
2017

housing
estate
award
2018

S-Classic

Referensi	Keterangan	No. Gambar	Pak	Harga (Rp) <i>(Sebelum PPN)</i>
Sakelar				
E31_1_2AR_WE_G3	10AX Sakelar 1 Gang - 1 Arah	1	10	27.700
E31_2_3A_WE_G3	10AX Sakelar 1 Gang - 2 Arah	1	10	34.000
E32_1_2AR_WE_G3	10AX Sakelar 2 Gang - 1 Arah	2	10	45.800
E32_2_3A_WE_G3	10AX Sakelar 2 Gang - 2 Arah	2	10	54.600
E33_1_2AR_WE_G3	10AX Sakelar 3 Gang - 1 Arah	3	10	66.500
E33_2_3A_WE_G3	10AX Sakelar 3 Gang - 2 Arah	3	10	75.300
E34_1_2AR_WE_G3	10AX Sakelar 4 Gang - 1 Arah	4	10	88.600
E35_1_2AR_WE_G3	10AX Sakelar 5 Gang - 1 Arah	5	10	135.600
ET36_1_2AR_WE	10AX Sakelar 6 Gang - 1 Arah	6	5	164.900
Kotak Kontak				
E426_16S_WE_G3	16A 1 Gang Kotak Kontak Tipe Schuko	7	10	37.100
E15NR_WE	13A 1 Gang Kotak Kontak Dengan Sakelar & Lampu Indikator Neon	8	10	83.900
E15NR_EP13_E238_B	Tusuk kontak, Kotak Kontak 13A dengan Neon & Outbowdoost	9	1	119.900
Plat Penutup				
E31X	1 Gang Plat Penutup	10	20	24.600
Kotak Kontak, Tv, Telepon & Data				
E31TV75_WE_G12	1 Gang Kotak Kontak TV Koaksial, 75 Ohm	11	10	78.800
ET01_4_WE	1 Gang 4 WIRE Telepon OUTLET - Putih	12	10	76.800
DCEKYBRWPS1PSWT_WE	1 Gang Kotak Kontak Data Cat 5	13	10	102.207
DC6KYBRWPS1PSWT_WE	1 Gang Kotak Kontak Data RJ45	13	10	112.456

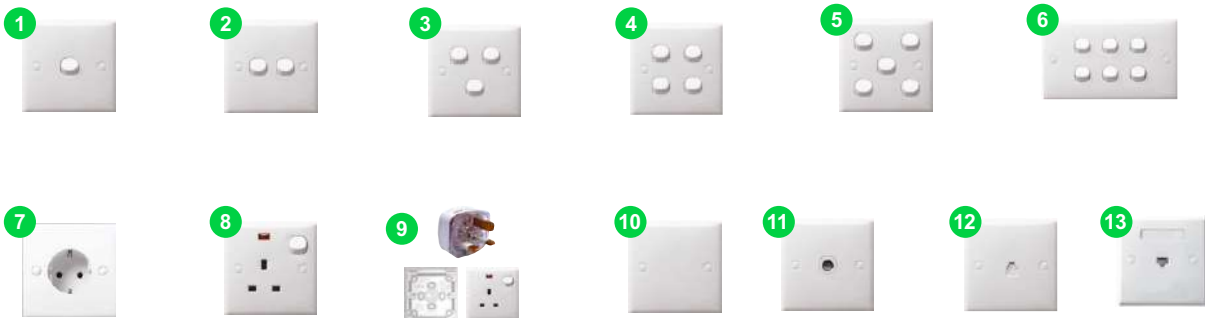

Life Is On

Schneider
Electric



Kavacha

Perlindungan sepanjang waktu





Kavacha bel pintu tahan cuaca, dengan proteksi IP 44, melindungi tamu Anda dari percikan air hujan

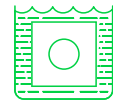

Jaga keluarga Anda dengan Kavacha pelindung sakelar dengan proteksi IP 55

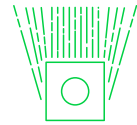
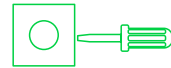



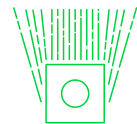
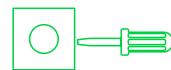



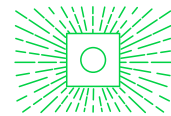
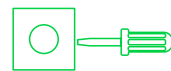









Pastikan area basah di rumah Anda terhindar dari bahaya kesetrum, dengan Kavacha pelindung kontak kontak dengan proteksi IP 55



Perlindungan titik listrik di luar rumah Anda terhadap debu dan cuaca dengan Kavacha AS dan Kavacha Isolator Switch IP 56



Kavacha

Gambar	Keterangan	Referensi	Pak	Harga (Sebelum PPN)
	Bel Pintu tahan cuaca dengan indikator LED, IP44, Putih	A3031WBP_WE	1	189.900
	Pelindung kotak kontak tahan cuaca, IP55, Putih	E223R_WE	1	91.800
	Pelindung kotak kontak tahan cuaca, IP55, Transparan	E223R_TR	1	91.800
	20A 250V Surface Mount Single Pole Isolating Switch	WHS20_GY	1	459.400
	35A 250V Surface Mount Single Pole Isolating Switch	WHS35_GY	1	533.300
	55A 250V Surface Mount Single Pole Isolating Switch	WHS55_GY	1	540.100
	20A 440V Surface Mount Double Pole Isolating Switch	WHD20_GY	1	485.100
	35A 440V Surface Mount Double Pole Isolating Switch	WHD35_GY	1	532.500
	55A 440V Surface Mount Double Pole Isolating Switch	WHD55_GY	1	625.100
	63A 440V Surface Mount Double Pole Isolating Switch	WHD63_GY	1	668.100
	20A 440V Surface Mount Triple Pole Isolating Switch	WHT20_GY	1	510.000
	35A 440V Surface Mount Triple Pole Isolating Switch	WHT35_GY	1	587.800
	55A 440V Surface Mount Triple Pole Isolating Switch	WHT55_GY	1	729.400
	63A 440V Surface Mount Triple Pole Isolating Switch	WHT63_GY	1	771.300
	80A 440V Surface Mount Triple Pole Isolating Switch	WHT80_GY	1	909.500
	SOCKET SWITCH 13A W-P BS1363.2	CSC313_GY	1	656.600
	13A 250V Surface Mount Single Pole Switched Socket with Neon	CSC313N_GY	1	682.000

Bel Pintu tahan cuaca dengan indikator LED



A3031WBP_WE

- Plat penutup polycarbonate yang rekat sehingga tidak meninggalkan celah untuk kebocoran.
- Locator dengan LED biru yang tahan lama dan hemat energi, memberikan visibilitas yang lebih tinggi.
- Penekan dolly besar yang mudah ditekan.
- Desain paling tipis dan menarik.

Kavacha Penutup Stop kontak Anti Air dengan Sertifikasi IP 55

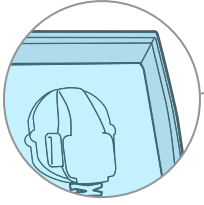

Penutup dengan desain cover yang transparan sehingga tidak mengganggu dekorasi rumah. Terbuat dari bahan polikarbonat yang tangguh dan tidak mudah pecah.

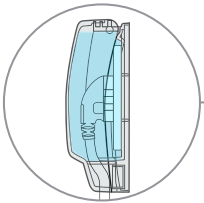

Penutup yang melengkung yang memberikan ruangan yang cukup untuk steker anda, sehingga dapat tetap melindungi titik listrik Anda dari air dan debu walaupun dengan posisi steker terpasang di stop kontak.

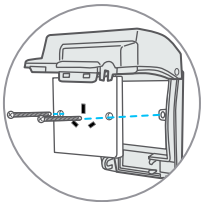

Cocok untuk Stop kontak dengan standar British (BS Standard dengan instalasi sekrup ukuran 86mm x 86mm). Pemasangan mudah dan cepat.

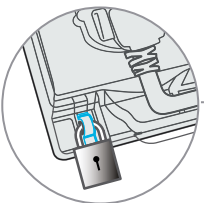

Tersedia pengait gembok untuk pengamanan tambahan.



Kavacha Model lainnya

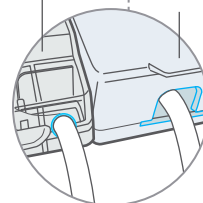

Tersedia jalur kabel dengan ukuran presisi untuk melindungi dengan sempurna dari air dan kelembapan bahkan dengan keadaan steker terpasang, Tidak seperti produk lain yang memberikan rongga cuku besar pada jalur kabelnya.

Life Is On

Schneider
Electric

ARGUS

Occupancy Sensor

Dual Teknologi

Gabungan teknologi Passive Infrared dan Ultrasonic memberikan efisiensi maksimum untuk berbagai aplikasi.

Peredup Otomatis

Cahaya lampu dapat menyesuaikan tingkat terang/gelap cahaya berdasarkan pengaturan Lux (tingkat cahaya).



Deteksi
Ultrasonik

+



Deteksi
Infra Merah



=

0

Deteksi
Tanpa Kesalahan

Argus Occupancy Sensor

Spesifikasi Produk		Dual-technology sensing	Dual-technology sensing	High-frequency sensing
Referensi		 CCT551011	 CCT551012	 CCT551023
Deskripsi		ARGUS Presence Dual-Tech (PIR & Ultrasonic) – 1 channel	ARGUS Presence Dual-Tech (PIR & Ultrasonic)- 2 channel	ARGUS High Bay Sensor (High Frequency) – 2 channel
Rentang Deteksi (Tinggi Instalasi: 2.5 m)		PIR: 8 m (diameter) US: adjustable up to 10 m x 16 m (oval shape)	PIR: 8 m (diameter) US: adjustable up to 10 m x 16 m (oval shape)	14 m (diameter) 10 m (diameter) at 6 – 10 m height
Beban 1 (Nilai Maksimal)	Lampu Pijar	2.000 W	2.000 W	2.000 W
	Lampu Holagen AC	1.000 W	1.000 W	1.000 W
	Lampu Holagen LV	1.000 VA	1.000 VA	1.000 VA
	Lampu TL	900 VA	900 VA	900 VA
	Lampu Hemat Energi (termasuk CFL dan Lampu PL)	80 VA	80 VA	80 VA
	Lampu LED	100 W	400 W	100 W
	Beban Kapasitif Jumlah maksimal ballast	100 µF	100 µF	100 µF
Beban 2 (Nilai Maksimal)	HVAC		5 A for ≤ 250 VAC, cos = 1 5 A for ≤ 30 VDC 1 A for ≤ 250 VAC, cos = 0,4	5 A for ≤ 250 VAC, cos = 1 5 A for ≤ 30 VDC 1 A for ≤ 250 VAC, cos = 0,4
Tegangan		230 VAC, 500 V 60 Hz	230 VAC, 500 V 60 Hz	230 VAC, 500 V 60 Hz
Harga (Sebelum PPN)		2.289.400	2.696.200	1.823.200

Spesifikasi Produk		Passive Infrared Sensing	Passive Infrared sensing
Referensi		 CCT570005	 CCT570003
Deskripsi		ARGUS Standard mini PIR Sensor	ARGUS Standard 2 Channel PIR Sensor
Rentang Deteksi (Tinggi Instalasi: 2.5 m)		6m (diameter)	7m (diameter)
Beban 1 (Nilai Maksimal)	Lampu Pijar	1.000 W	1.000 W
	Lampu Holagen AC	800 W	900 W
	Lampu Holagen LV	315 W	250 VA
	Lampu TL	250 VA	200 VA
	Lampu Hemat Energi (termasuk CFL dan Lampu PL)	80 VA	80 VA
	Lampu LED	100 W	100 W
	Beban Kapasitif Jumlah maksimal ballast	25 µF	14 µF (10 A)
Beban 2 (Nilai Maksimal)	HVAC	-	5 A for ≤ 250 VAC, cos = 1 5 A for ≤ 30 VDC 1 A for ≤ 250 VAC, cos = 0,4
Tegangan		230 VAC, 500 V 60 Hz	230 VAC, 50 Hz
Harga (Sebelum PPN)		1.010.630	1.066.490

Life Is On

Schneider
Electric



Domae, Pilihan terbaik.

Pastikan rumah Anda terlindungi oleh perangkat proteksi arus listrik yang berkualitas.



MCB RCBO RCCB SPD

MCB Domae



Pole
Rating Arus

1 Pole
2 - 63 A

2 Pole
2 - 63 A

3 Pole
6 - 63 A

MCB melindungi dari :



Beban berlebih



Hubung singkat
atau korsleting



Breaking Capacity **6.000A (6kA)**

Pada saat terjadi arus pendek (korsleting), arus akan melonjak sangat tinggi. MCB Domae mampu menahan korsleting hingga 6.000A



Daya tahan mekanikal **20.000 kali**

MCB Domae Baru memiliki daya tahan mekanikal, atau daya tahan MCB untuk dioperasikan on dan off (toggle klak-klik naik dan turun) **TANPA** aliran listrik, sebesar 20.000 kali



Daya tahan elektrikal **10.000 kali**

MCB Domae Baru memiliki daya tahan elektrikal, atau daya tahan MCB untuk dioperasikan on dan off (toggle klak-klik naik dan turun) **DENGAN** aliran listrik, sebesar 10.000 kali



MCB Domae sudah bersertifikat **SNI**



RCCB Domae

Pastikan rumah Anda terlindungi dari kesetrum dengan menggunakan RCCB Domae

RCCB Domae adalah perangkat listrik yang mampu mencegah terjadinya kesetrum terhadap penghuni rumah. Kemampuannya mendeteksi dan mencegah terjadinya kesetrum memberikan rasa aman bagi kita.

* **CATATAN:** Beberapa tukang listrik mengenal produk ini sebagai ELCB.

- RCCB Domae sensitivitas 30mA untuk perlindungan manusia, sensitivitas 300mA untuk perlindungan aset atau mesin
- Pastikan bahwa instalasi listrik rumah Anda sudah terpasang grounding
- Setelah selesai instalasi RCCB Domae, jangan lupa untuk menekan tombol test untuk memeriksa apakah RCCB Domae berfungsi dengan baik
- Jika setelah di tekan tombol test, tuas/toggle yang berwarna Oranye turun (off), maka RCCB Domae berfungsi dengan baik. Naikkan kembali tuas/toggle ke arah atas (on)

Petunjuk Instalasi RCCB Domae

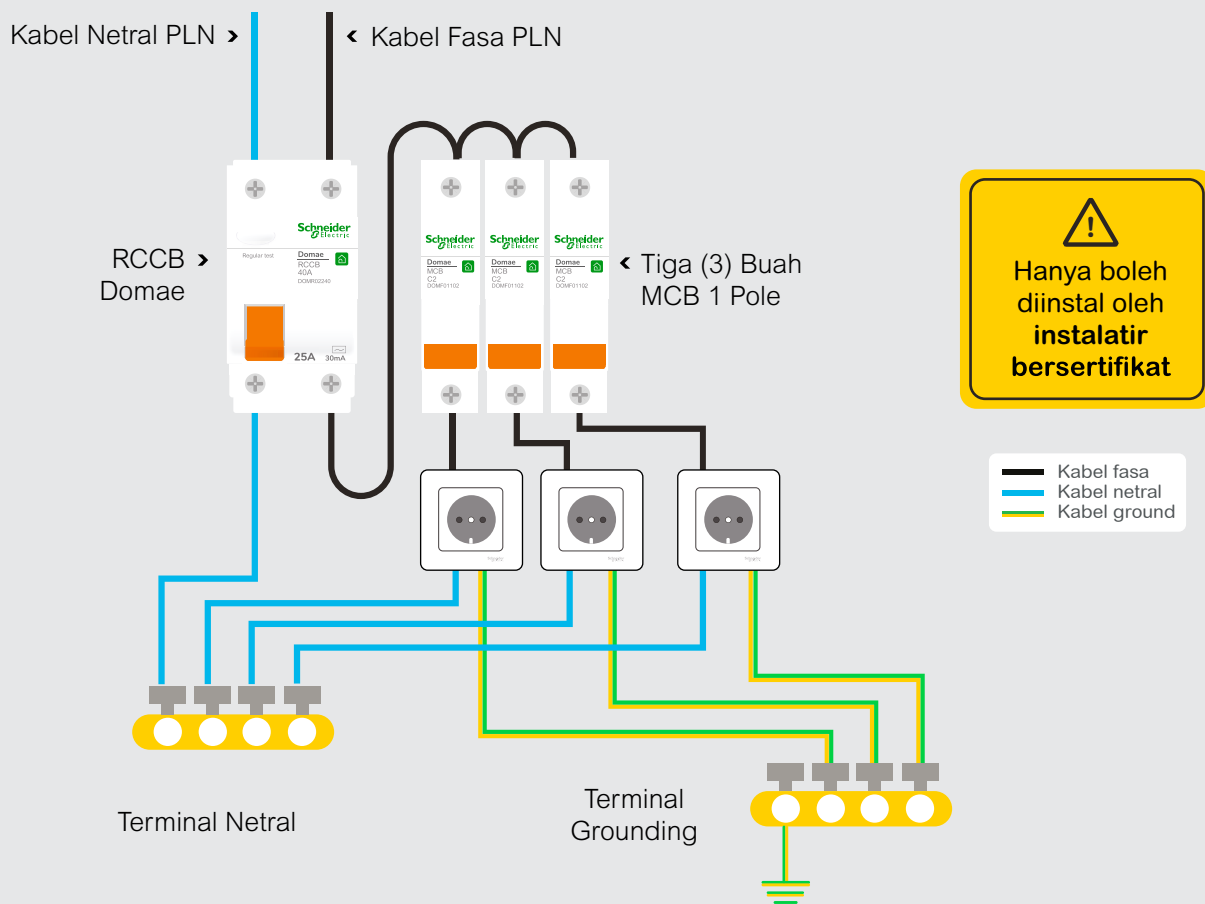



RCBO Slim Domae

RCBO Slim Domae adalah inovasi yang merupakan gabungan Antara MCB dengan RCCB.

Fungsi RCBO Slim Domae



Melindungi dari kesetrum



Melindungi dari korsleting (short circuit)



Melindungi dari beban lebih



Surge arrester (SPD Domae)

Surge Arrester (SPD) Domae adalah perangkat listrik yang melindungi peralatan elektronik terhadap bahaya induksi petir.

Fungsi SPD Domae



Melindungi peralatan elektronik dari bahaya induksi petir

Petunjuk Instalasi RCBO Slim dan SPD Domae

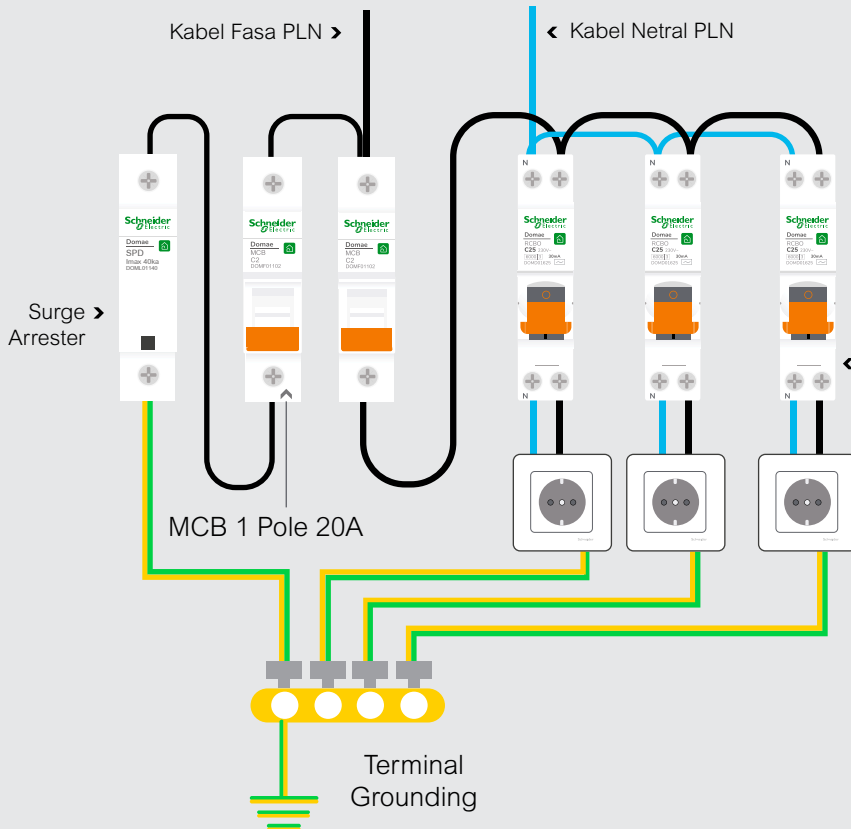

* CATATAN:

Rangkaian ini adalah simulasi instalasi RCBO Slim dan SPD Domae pada satu rangkaian.



1. Untuk instalasi RCBO Slim Domae saja, hilangkan SPD Domae dan MCB Domae 20A
2. Untuk instalasi SPD dan MCB Domae saja, gantikan 3 RCBO Slim Domae dengan 3 MCB Domae.

◀ Tiga (3) Buah RCBO Slim Domae



— Kabel fasa
 — Kabel netral
 — Kabel ground

MCB Domae



Gambar	Kutub	Rating Arus	Referensi	Pak	Harga (Sebelum PPN)
	1	2	DOMF01102	12	120.500
		4	DOMF01104	12	120.500
		6	DOMF01106	12	96.500
		10	DOMF01110	12	96.500
		16	DOMF01116	12	96.500
		20	DOMF01120	12	96.500
		25	DOMF01125	12	107.000
		32	DOMF01132	12	110.500
		40	DOMF01140	12	134.500
		50	DOMF01150	12	278.000
	2	63	DOMF01163	12	278.000
		2	DOMF01202	6	353.500
		4	DOMF01204	6	353.500
		6	DOMF01206	6	271.500
		10	DOMF01210	6	271.500
		16	DOMF01216	6	271.500
		20	DOMF01220	6	271.500
		25	DOMF01225	6	309.500
		32	DOMF01232	6	322.500
		40	DOMF01240	6	380.500
	3	63	DOMF01263	6	625.000
		6	DOMF01306	6	442.000
		10	DOMF01310	4	442.000
		16	DOMF01316	4	442.000
		20	DOMF01320	4	442.000
		25	DOMF01325	4	476.500
		32	DOMF01332	4	514.000
		40	DOMF01340	4	602.000
		50	DOMF01350	4	994.000
		63	DOMF01363	4	994.000

MCB Box

Gambar	Modul	Tinggi	Lebar	Tebal	Referensi	Harga (Sebelum PPN)
	4	222	136	92	DOMH12104F	120.500
	8	222	208	92	DOMH12108F	171.500
	12	222	280	92	DOMH12112F	217.500

RCBO Slim & ELCB Domae

Gambar	Kutub	Sensitivitas	Rating Arus	Referensi	Pak	Harga (Sebelum PPN)
RCBO Slim						
	1P + N	30 mA	6	DOMD01606	12	489.500
			10	DOMD01610	12	489.500
			16	DOMD01616	12	489.500
			20	DOMD01620	12	489.500
			25	DOMD01625	12	538.500

ELCB/RCCB						
	1P + N	30 mA	25	DOMR01225	6	441.000
			40	DOMR01240	6	484.500
			63	DOMR01263	6	630.000
			25	DOMR02225	6	463.000
			40	DOMR02240	6	509.000
			63	DOMR02263	6	661.500
	3P + N	30 mA	25	DOMR01425	3	661.500
			40	DOMR01440	3	727.000
			63	DOMR01463	3	982.500
			25	DOMR02425	3	694.500
			40	DOMR02440	3	794.000
			63	DOMR02463	3	992.000

Surge Arrester

Gambar	Tipe	Referensi	Pak	Harga (Sebelum PPN)
Surge Arrester PF 40kA				
	Domae PF 1P	DOML01140	12	354.000
	Domae PF 1P+N	DOML01640	6	832.000
	Domae PF 3P	DOML01340	3	1.168.000
	Domae PF 3P+N	DOML01740	3	1.503.500

Mini Pragma

Gambar	Baris	Modul (18mm)	Tinggi	Lebar	Tebal	Referensi	Harga (Sebelum PPN)
Transparan (Inbow)							
	1	8	252	222	98	MIP22108S	726.500
	1	12	252	294	98	MIP22112S	620.000
	1	18	252	402	98	MIP22118S	699.500
	2	24	377	294	98	MIP22212S	797.000
	3	36	502	294	98	MIP22312S	1.168.000
Putih (Inbow)							
	1	8	252	222	98	MIP22108	475.000
	1	12	252	294	98	MIP22112	564.000
	1	18	252	402	98	MIP22118	704.500
	2	24	377	294	98	MIP22212	756.000
	3	36	502	294	98	MIP22312	1.031.000

Life Is On

Schneider
Electric

Easy9

MCB dan RCCB untuk rumah tinggal
dengan kualitas terpercaya



MCB Easy9



MCB Easy9 tersedia untuk 1 dan 3 pole, dari 2 hingga 40A yang melindungi dari:



Beban berlebih



Korsleting



Breaking Capacity **6.000A (6kA)**

Pada saat terjadi arus pendek (korsleting), arus akan melonjak sangat tinggi. MCB Domae mampu menahan korsleting hingga 6.000A



Daya tahan mekanikal **20.000 kali**

MCB Domae Baru memiliki daya tahan mekanikal, atau daya tahan MCB untuk dioperasikan on dan off (toggle klak-klik naik dan turun) TANPA aliran listrik, sebesar 20.000 kali



Daya tahan elektrikal **10.000 kali**

MCB Domae Baru memiliki daya tahan elektrikal, atau daya tahan MCB untuk dioperasikan on dan off (toggle klak-klik naik dan turun) DENGAN aliran listrik, sebesar 10.000 kali



MCB Easy9 sudah bersertifikat **SNI**

RCCB/ELCB Easy9



RCCB Easy9 Berfungsi untuk:



Melindungi dari kesetrum



RCCB/ELCB Easy9 sudah bersertifikat SNI

Do's And Dont's



RCCB Easy9 memiliki sensitivitas sebesar 30mA yang didesain untuk residential khususnya untuk perlindungan dari electric shock.



Pastikan bahwa listrik rumah sudah terpasang grounding.



Setelah selesai instalasi RCCB Easy9, jangan lupa untuk menekan tombol test untuk memeriksa apakah RCCB Easy9 berfungsi dengan baik.



Jika setelah ditekan tombol test, tuas/ toggle yang berwarna hitam turun (off), maka RCCB Easy9 berfungsi dengan baik. Naikkan kembali tuas/toggle ke atas.



Sekalipun sudah terpasang RCCB, instalasi listrik yang sudah bermasalah (akibat umur pakai/insulasi yang rusak tetap menjadi prioritas untuk segera diperbaiki.

Petunjuk Instalasi RCCB Easy9

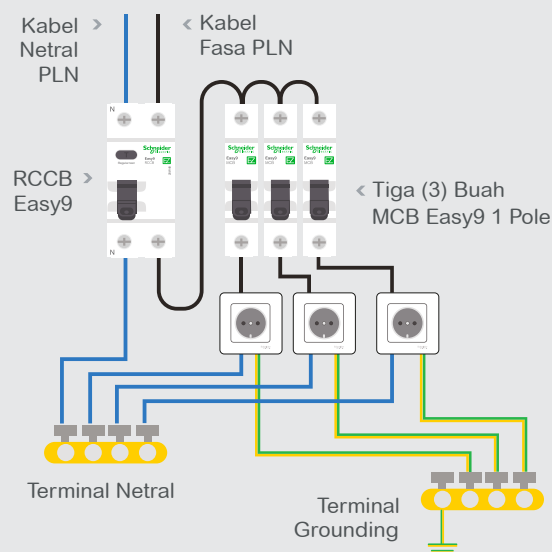

— Kabel fasa
— Kabel netral
— Kabel ground

Miniature Circuit Breaker (MCB) & RCCB/ELCB

MCB Easy9 - Kurva C



1 Kutub



3 Kutub

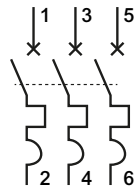

Jumlah Kutub	Pengenal (A)	Referensi	Harga (Rp) (Sebelum PPN)
1 Kutub	2A	EZ9F54102	51.500
	4A	EZ9F54104	51.500
	6A	EZ9F54106	50.000
	10A	EZ9F54110	50.000
	16A	EZ9F54116	50.000
	20A	EZ9F54120	50.000
	25A	EZ9F54125	52.500
	32A	EZ9F54132	56.500
	40A	EZ9F54140	56.500
	3 Kutub	6A	EZ9F54306
10A		EZ9F54310	180.500
16A		EZ9F54316	180.500
20A		EZ9F54320	181.000
25A		EZ9F54325	218.500
32A		EZ9F54332	253.000
40A		EZ9F54340	314.500



RCCB / ELCB Easy9

Jumlah Kutub	Pengenal (A)	Sensitivitas	Referensi	Harga (Rp) (Sebelum PPN)
1P+N	25A	30 mA	EZ9R04225	309.500
1P+N	40A	30 mA	EZ9R04240	340.500
3P+N	40A	30 mA	EZ9R04440	513.500

Hanya tersedia di area luar Jakarta

GoPact MCCB

Robust, Simple, Compact, Standalone



- ✓ Arus nominal sampai 800 A
- ✓ Seluruh fasa dan netral terlindungi
- ✓ Trip unit dilengkapi dengan thermal adjustability
- ✓ Plug-in base tersedia dari GoPact MCCB 200
- ✓ Electronic trip unit dari 500 sampai 800 A

Breaking capacity are at 415 V AC

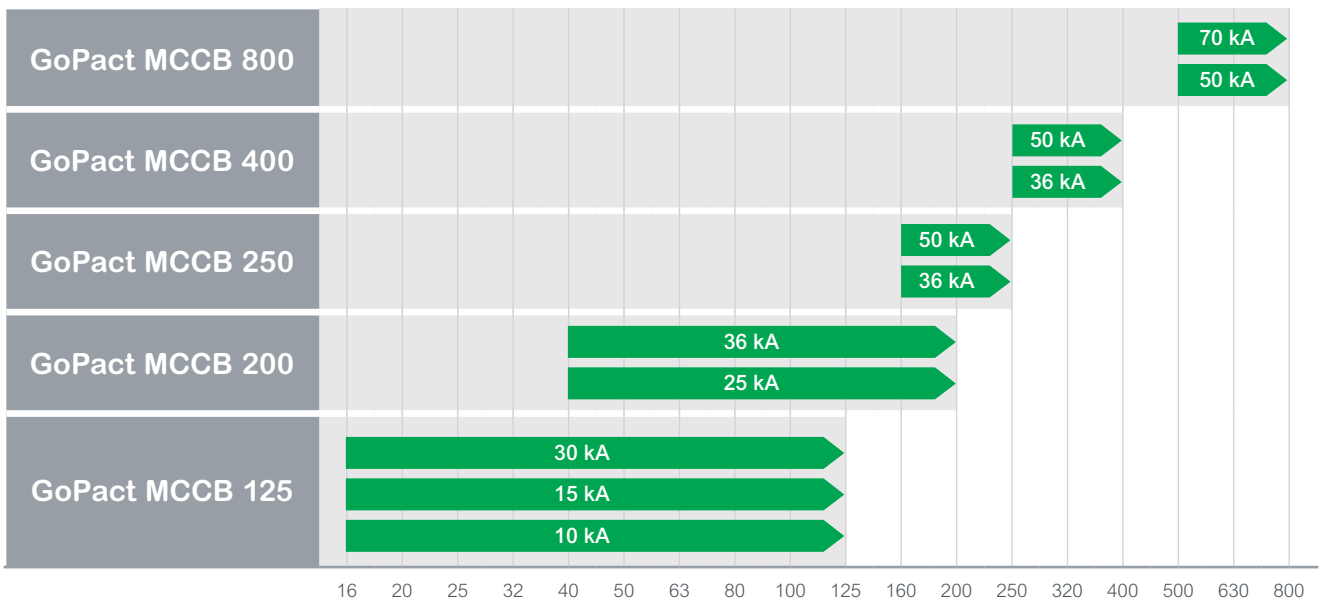

GoPact MCCB

GoPact Molded Case Circuit Breaker 125

GoPact Molded Case Circuit Breaker 125

Dilengkapi dengan unit trip termal-magnetik TM-D

Fixed							Adjustable						
Rating	3P 3D	Harga (Rp) (Sebelum PPN)	SS	4P 4D	Harga (Rp) (Sebelum PPN)	SS	Rating	3P 3D	Harga (Rp) (Sebelum PPN)	SS	4P 4D	Harga (Rp) (Sebelum PPN)	SS
Icu = 10 kA at 415 V AC													
16 A	G12T3F16	772.000	1	G12T4F16	1.043.000	2	13-16 A	G12T3A16	1.103.000	2	G12T4A16	1.521.000	2
20 A	G12T3F20	772.000	1	G12T4F20	1.043.000	2	16-20 A	G12T3A20	1.103.000	2	G12T4A20	1.521.000	2
25 A	G12T3F25	772.000	1	G12T4F25	1.043.000	2	20-25 A	G12T3A25	1.103.000	2	G12T4A25	1.521.000	2
32 A	G12T3F32	772.000	1	G12T4F32	1.043.000	2	26-32 A	G12T3A32	1.103.000	2	G12T4A32	1.521.000	2
40 A	G12T3F40	772.000	1	G12T4F40	1.043.000	2	32-40 A	G12T3A40	1.103.000	2	G12T4A40	1.521.000	2
50 A	G12T3F50	772.000	1	G12T4F50	1.043.000	2	40-50 A	G12T3A50	1.103.000	2	G12T4A50	1.521.000	2
63 A	G12T3F63	772.000	1	G12T4F63	1.043.000	2	51-63 A	G12T3A63	1.103.000	2	G12T4A63	1.521.000	2
80 A	G12T3F80	772.000	1	G12T4F80	1.043.000	2	64-80 A	G12T3A80	1.103.000	2	G12T4A80	1.521.000	2
100 A	G12T3F100	772.000	1	G12T4F100	1.043.000	2	80-100 A	G12T3A100	1.103.000	2	G12T4A100	1.521.000	2
125 A	G12T3F125	947.000	1	G12T4F125	1.292.000	2	100-125 A	G12T3A125	1.275.000	2	G12T4A125	1.608.000	2
Icu = 15 kA at 415 V AC													
16 A	G12E3F16	818.000	1	G12E4F16	1.105.000	2	13-16 A	G12E3A16	1.159.000	2	G12E4A16	1.573.000	2
20 A	G12E3F20	818.000	1	G12E4F20	1.105.000	2	16-20 A	G12E3A20	1.159.000	2	G12E4A20	1.573.000	2
25 A	G12E3F25	818.000	1	G12E4F25	1.105.000	2	20-25 A	G12E3A25	1.159.000	2	G12E4A25	1.573.000	2
32 A	G12E3F32	818.000	1	G12E4F32	1.105.000	2	26-32 A	G12E3A32	1.159.000	2	G12E4A32	1.573.000	2
40 A	G12E3F40	818.000	1	G12E4F40	1.105.000	2	32-40 A	G12E3A40	1.159.000	2	G12E4A40	1.573.000	2
50 A	G12E3F50	818.000	1	G12E4F50	1.105.000	2	40-50 A	G12E3A50	1.159.000	2	G12E4A50	1.573.000	2
63 A	G12E3F63	818.000	1	G12E4F63	1.105.000	2	51-63 A	G12E3A63	1.159.000	2	G12E4A63	1.573.000	2
80 A	G12E3F80	818.000	1	G12E4F80	1.105.000	2	64-80 A	G12E3A80	1.106.000	2	G12E4A80	1.573.000	2
100 A	G12E3F100	818.000	1	G12E4F100	1.105.000	2	80-100 A	G12E3A100	1.106.000	2	G12E4A100	1.573.000	2
125 A	G12E3F125	1.049.000	1	G12E4F125	1.376.000	2	100-125 A	G12E3A125	1.411.000	2	G12E4A125	1.764.000	2
Icu = 30 kA at 415 V AC													
16 A	G12F3F16	1.018.000	1	G12F4F16	1.218.000	2	13-16 A	G12F3A16	1.227.000	2	G12F4A16	1.770.000	2
20 A	G12F3F20	1.018.000	1	G12F4F20	1.218.000	2	16-20 A	G12F3A20	1.227.000	2	G12F4A20	1.770.000	2
25 A	G12F3F25	1.018.000	1	G12F4F25	1.218.000	2	20-25 A	G12F3A25	1.227.000	2	G12F4A25	1.770.000	2
32 A	G12F3F32	1.018.000	1	G12F4F32	1.218.000	2	26-32 A	G12F3A32	1.227.000	2	G12F4A32	1.770.000	2
40 A	G12F3F40	1.018.000	1	G12F4F40	1.218.000	2	32-40 A	G12F3A40	1.227.000	2	G12F4A40	1.770.000	2
50 A	G12F3F50	1.018.000	1	G12F4F50	1.218.000	2	40-50 A	G12F3A50	1.227.000	2	G12F4A50	1.770.000	2
63 A	G12F3F63	1.018.000	1	G12F4F63	1.218.000	2	51-63 A	G12F3A63	1.227.000	1	G12F4A63	1.770.000	2
80 A	G12F3F80	1.018.000	1	G12F4F80	1.218.000	2	64-80 A	G12F3A80	1.227.000	1	G12F4A80	1.839.000	2
100 A	G12F3F100	1.018.000	1	G12F4F100	1.218.000	2	80-100 A	G12F3A100	1.227.000	2	G12F4A100	1.839.000	2
125 A	G12F3F125	1.307.000	1	G12F4F125	1.725.000	2	100-125 A	G12F3A125	1.527.000	2	G12F4A125	2.062.000	2



GoPact MCCB

GoPact Molded Case Circuit Breaker 200/250/400

GoPact Molded Case Circuit Breaker 200

Dilengkapi dengan unit trip termal-magnetik TM-D



Rating	Adjustable					
	3P 3D	Harga (Rp) (Sebelum PPN)	SS	4P 4D	Harga (Rp) (Sebelum PPN)	SS
Icu = 25 kA at 415 V AC						
28-40 A	G20B3A40	1.503.000	2	G20B4A40	1.989.000	2
35-50 A	G20B3A50	1.503.000	2	G20B4A50	1.989.000	2
45-63 A	G20B3A63	1.503.000	2	G20B4A63	1.989.000	2
56-80 A	G20B3A80	1.503.000	2	G20B4A80	1.989.000	2
70-100 A	G20B3A100	1.503.000	1	G20B4A100	1.989.000	2
88-125 A	G20B3A125	1.706.000	1	G20B4A125	2.279.000	2
112-160 A	G20B3A160	1.791.000	1	G20B4A160	2.401.000	2
140-200 A	G20B3A200	1.981.000	1	G20B4A200	2.673.000	2
Icu = 36 kA at 415 V AC						
28-40 A	G20F3A40	1.595.000	2	G20F4A40	2.162.000	2
35-50 A	G20F3A50	1.595.000	2	G20F4A50	2.162.000	2
45-63 A	G20F3A63	1.595.000	2	G20F4A63	2.162.000	2
56-80 A	G20F3A80	1.595.000	2	G20F4A80	2.162.000	2
70-100 A	G20F3A100	1.595.000	2	G20F4A100	2.162.000	2
88-125 A	G20F3A125	1.829.000	1	G20F4A125	2.478.000	2
112-160 A	G20F3A160	1.934.000	1	G20F4A160	2.864.000	2
140-200 A	G20F3A200	2.153.000	1	G20F4A200	3.160.000	2

GoPact Molded Case Circuit Breaker 250

Dilengkapi dengan unit trip termal-magnetik TM-D



Rating	Adjustable					
	3P 3D	Harga (Rp) (Sebelum PPN)	SS	4P 4D	Harga (Rp) (Sebelum PPN)	SS
Icu = 25 kA at 415 V AC						
112-160 A	G25B3A160	2.299.000	2	G25B4A160	3.034.000	2
140-200 A	G25B3A200	2.369.000	2	G25B4A200	3.104.000	2
175-250 A	G25B3A250	2.369.000	1	G25B4A250	3.104.000	2
Icu = 36 kA at 415 V AC						
112-160 A	G25F3A160	2.499.000	2	G25F4A160	3.387.000	2
140-200 A	G25F3A200	2.499.000	2	G25F4A200	3.527.000	2
175-250 A	G25F3A250	2.499.000	1	G25F4A250	3.527.000	2

GoPact Molded Case Circuit Breaker 400

Dilengkapi dengan unit trip termal-magnetik TM-D



Rating	Adjustable					
	3P 3D	Harga (Rp) (Sebelum PPN)	SS	4P 4D	Harga (Rp) (Sebelum PPN)	SS
Icu = 36 kA at 415 V AC						
175-250 A	G40F3A250	4.911.000	2	G40F4A250	6.629.000	2
224-320 A	G40F3A320	4.911.000	2	G40F4A320	6.629.000	2
280-400 A	G40F3A400	4.911.000	1	G40F4A400	6.629.000	2
Icu = 50 kA at 415 V AC						
175-250 A	G40N3A250	5.598.000	2	G40N4A250	7.557.000	2
224-320 A	G40N3A320	5.598.000	2	G40N4A320	7.557.000	2
280-400 A	G40N3A400	5.598.000	2	G40N4A400	7.557.000	2

GoPact MCCB

GoPact Molded Case Circuit Breaker 800



GoPact Molded Case Circuit Breaker 800

Dilengkapi dengan unit trip termal-magnetik TM-D

Rating	Adjustable					
	3P 3D	Harga (Rp) (Sebelum PPN)	SS	4P 4D	Harga (Rp) (Sebelum PPN)	SS
Icu = 50 kA at 415 V AC						
350-500 A	G80N3TM500	8.546.000	2	G80N4TM500	11.538.000	2
441-630 A	G80N3TM630	8.546.000	1	G80N4TM630	11.538.000	2
560-800 A	G80N3TM800	11.394.000	2	G80N4TM800	15.660.000	2
Icu = 70 kA at 415 V AC						
350-500 A	G80H3TM500	9.370.000	2	G80H4TM500	12.418.000	2
441-630 A	G80H3TM630	9.370.000	2	G80H4TM630	12.418.000	2
560-800 A	G80H3TM800	12.494.000	2	G80H4TM800	16.558.000	2

GoPact Molded Case Circuit Breaker 800

Dilengkapi dengan unit trip elektrik ETU 2.4



Rating	Adjustable					
	3P 3D	Harga (Rp) (Sebelum PPN)	SS	4P 4D	Harga (Rp) (Sebelum PPN)	SS
Icu = 50 kA at 415 V AC						
125-500 A	G80N3E500	11.482.000	2	G80N4E500	14.926.000	2
158-630 A	G80N3E630	11.482.000	2	G80N4E630	14.926.000	2
200-800 A	G80N3E800	15.308.000	1	G80N4E800	22.799.000	2
Icu = 70 kA at 415 V AC						
125-500 A	G80H3E500	12.589.000	2	G80H4E500	17.940.000	2
158-630 A	G80H3E630	12.589.000	2	G80H4E630	17.940.000	2
200-800 A	G80H3E800	16.785.000	2	G80H4E800	26.538.000	2

GoPact MCCB

Internal Accessories

Voltage release (MN) / Shunt trip (MX)



Rating	Referensi	Harga (Rp) (Sebelum PPN)	SS
GoPact MCCB 125 AC 50/60 Hz			
MN			
110 V	G12UVR110AC	789.000	2
240 V	G12UVR230AC	789.000	1
415 V	G12UVR415AC	789.000	2
GoPact MCCB 125 AC 50/60Hz			
MX			
110-415 V	G12SHT415AC	542.000	2
GoPact MCCB 200-250 AC 50/60Hz			
MN			
110 V	G20-25UVR110AC	902.000	2
240 V	G20-25UVR240AC	902.000	1
415 V	G20-25UVR415AC	902.000	2
GoPact MCCB 200-250 AC/DC 50/60Hz			
MX			
24 V	G20-25SHT24DC	617.000	2
48 V	G20-25SHT48DC	617.000	2
110 V	G20-25SHT110AC	617.000	2
240 V	G20-25SHT240AC	617.000	1
415 V	G20-25SHT415AC	617.000	2
GoPact MCCB 400-800 AC/DC 50/60Hz			
MN			
110 V	G40-80UVR110AC	961.000	2
240 V	G40-80UVR240AC	961.000	2
415 V	G40-80UVR415AC	961.000	2
GoPact MCCB 400-800 AC/DC 50/60Hz			
MX			
24 V	G40-80SHT24DC	686.000	2
48 V	G40-80SHT48DC	689.000	2
110 V	G40-80SHT110AC	686.000	2
240 V	G40-80SHT240AC	713.000	2
415 V	G40-80SHT415AC	720.000	2

Auxiliary contact (OF/SD)



Rating	Referensi	Harga (Rp) (Sebelum PPN)	SS
Auxiliary contact (OF/SD) GoPact MCCB 125-250			
240 V	G12-25AUX240	299.000	1
Auxiliary contact (OF/SD) GoPact MCCB 400-800			
240 V	G40-80AUX240	334.000	2

GoPact MCCB

External Accessories

External Accessories



	Referensi	Harga (Rp) (Sebelum PPN)	SS	Referensi	Harga (Rp) (Sebelum PPN)	SS
Rotary Handle	Direct			Extended		
GoPact MCCB 125	G12ROTDS	484.000	2	G12ROTE	837.000	2
GoPact MCCB 200	G20ROTDS	589.000	2	G20ROTE	1.041.000	2
GoPact MCCB 250	G25ROTDS	620.000	2	G25ROTE	1.095.000	2
GoPact MCCB 400	G40ROTDS	957.000	2	G40ROTE	1.509.000	2
GoPact MCCB 800	G80ROTDS	1.008.000	2	G80ROTE	1.588.000	2



Interphase barriers set of 2						
GoPact MCCB 125	G12FASB2	50.000	2			
GoPact MCCB 200	G20FASB2	55.000	2			
GoPact MCCB 250	G25FASB2	74.000	2			
GoPact MCCB 400-800	G40-80FASB2	112.000	2			
GoPact MCCB 200 Plug In Base Insulator	G20PLUGFASB2	69.000	2			



	3P			4P		
Short Terminal shield						
GoPact MCCB 125	G12STSHD3P	121.000	2	G12STSHD4P	140.000	2
GoPact MCCB 200	G20STSHD3P	131.000	2	G20STSHD4P	157.000	2
GoPact MCCB 250	G25STSHD3P	176.000	2	G25STSHD4P	230.000	2
GoPact MCCB 400	G40STSHD3P	185.000	2	G40STSHD4P	242.000	2
GoPact MCCB 800	G80STSHD3P	277.000	2	G80STSHD4P	314.000	2



	3P			4P		
Long Terminal shield						
GoPact MCCB 125	G12LTSHD3P	326.000	2	G12LTSHD4P	366.000	2
GoPact MCCB 200	G20LTSHD3P	344.000	2	G20LTSHD4P	423.000	2
GoPact MCCB 250	G25LTSHD3P	482.000	2	G25LTSHD4P	592.000	2
GoPact MCCB 400	G40LTSHD3P	508.000	2	G40LTSHD4P	624.000	2
GoPact MCCB 800	G80LTSHD3P	660.000	2	G80LTSHD4P	810.000	2



	3P			4P		
Plug-In Base						
GoPact MCCB 200	G20PBASE3P	2.102.000	2	G20PBASE4P	2.724.000	2
GoPact MCCB 250	G25PBASE3P	2.492.000	2	G25PBASE4P	3.201.000	2
GoPact MCCB 400	G40PBASE3P	4.011.000	2	G40PBASE4P	4.926.000	2
GoPact MCCB 800	G80PBASE3P	11.988.000	2	G80PBASE4P	13.940.000	2



	3P			4P		
Conversion kit for Plug-in Base						
GoPact MCCB 200	G20PLUGKIT3P	897.000	2	G20PLUGKIT4P	1.109.000	2
GoPact MCCB 250	G25PLUGKIT3P	1.128.000	2	G25PLUGKIT4P	1.433.000	2
GoPact MCCB 400	G40PLUGKIT3P	2.856.000	2	G40PLUGKIT4P	3.636.000	2
GoPact MCCB 800	G80PLUGKIT3P	6.300.000	2	G80PLUGKIT4P	7.365.000	2



	3P			4P		
Terminal Extension Spreaders						
GoPact MCCB 125	G12SPDR3P	388.000	2	G12SPDR4P	517.000	2
GoPact MCCB 160-200 A	G20SPDR3P	410.000	2	G20SPDR4P	546.000	2
GoPact MCCB 250	G25SPDR3P	463.000	2	G25SPDR4P	629.000	2
GoPact MCCB 400	G40SPDR3P	1.263.000	2	G40SPDR4P	1.684.000	2
GoPact MCCB 800-630 A	G80SPDR3P630	2.932.000	2	G80SPDR4P630	3.378.000	2
GoPact MCCB 800-800 A	G80SPDR3P800	3.722.000	2	G80SPDR4P800	4.291.000	2



	3P			4P		
Terminal Extension Spreaders						
GoPact MCCB 200	G20RC3P	992.000	2	G20RC4P	1.421.000	2
GoPact MCCB 250	G25RC3P	1.167.000	2	G25RC4P	1.671.000	2
GoPact MCCB 400	G40RC3P	2.040.000	2	G40RC4P	2.808.000	2
GoPact MCCB 800	G80RC3P	2.399.000	2	G80RC4P	3.451.000	2



	3P			4P		
Steel bare cable connectors						
GoPact MCCB 200*	G20SBC3P	345.000	2	G20SBC4P	441.000	2
GoPact MCCB 250	G25SBC3P	695.000	2	G25SBC4P	926.000	2
GoPact MCCB 400	G40SBC3P	904.000	2	G40SBC4P	1.154.000	2

*) Do not use steel bare cable connectors for 200 A

EasyPact™ CVS

Moulded Case Circuit Breaker 100A s/d 250A



EasyPact CVS 100/160/250 B/F/N dengan TMD

- Arus Nominal (In) : 100 A/160 A/250 A
- Kapasitas Pemutusan : B (25), F(36) dan N (50) kA pada 380/415 VAC.
- Ics = 100% Icu.⁽¹⁾
- Trip unit :
 - TMD : Thermal Magnetic (adjustable 0.7 - 1 x In)
Untuk proteksi beban distribusi.
- Fixed type, front connection.
- Memenuhi standar IEC 60947-2.

Trip Unit	Ir (A)	Im (A)	3P	Harga (Rp) (Sebelum PPN)	SS	4P	Harga (Rp) (Sebelum PPN)	SS
EasyPact CVS100-250 B (25 kA)								
TM16D	11.2-16	190	LV510300	1.570.000	1 - MTS	LV510310	2.056.000	1 - MTS
TM25D	17.5-25	300	LV510301	1.570.000	1 - MTS	LV510311	2.056.000	1 - MTS
TM32D	22.4-32	400	LV510302	1.570.000	1 - MTS	LV510312	2.056.000	1 - MTS
TM40D	28-40	500	LV510303	1.570.000	1 - MTS	LV510313	2.056.000	1 - MTS
TM50D	35-50	500	LV510304	1.570.000	1 - MTS	LV510314	2.056.000	1 - MTS
TM63D	44.1-63	500	LV510305	1.570.000	1 - MTS	LV510315	2.234.000	1 - MTS
TM80D	56-80	640	LV510306	1.570.000	1 - MTS	LV510316	2.234.000	1 - MTS
TM100D	70-100	800	LV510307	1.570.000	1 - MTS	LV510317	2.234.000	1 - MTS
TM125D	87.5-125	1250	LV516302	2.248.000	1 - MTS	LV516312	2.925.000	1 - MTS
TM160D	112-160	1250	LV516303	2.611.000	1 - MTS	LV516313	3.396.000	1 - MTS
TM200D	140-200	2000	LV525302	2.921.000	1 - MTS	LV525312	3.664.000	1 - MTS
TM250D	175-250	2500	LV525303	3.005.000	1 - MTS	LV525313	3.771.000	1 - MTS
EasyPact CVS100-250 F (36 kA)								
TM16D	11.2-16	190	LV510330	1.705.000	1 - MTS	LV510340	2.263.000	2 - MTO
TM25D	17.5-25	300	LV510331	1.705.000	1 - MTS	LV510341	2.263.000	2 - MTO
TM32D	22.4-32	400	LV510332	1.705.000	1 - MTS	LV510342	2.263.000	2 - MTO
TM40D	28-40	500	LV510333	1.705.000	1 - MTS	LV510343	2.263.000	2 - MTO
TM50D	35-50	500	LV510334	1.705.000	1 - MTS	LV510344	2.263.000	2 - MTO
TM63D	44.1-63	500	LV510335	1.728.000	1 - MTS	LV510345	2.328.000	1 - MTS
TM80D	56-80	640	LV510336	1.728.000	1 - MTS	LV510346	2.328.000	1 - MTS
TM100D	70-100	800	LV510337	1.728.000	1 - MTS	LV510347	2.328.000	1 - MTS
TM125D	87.5-125	1250	LV516332	2.472.000	1 - MTS	LV516342	2.991.000	2 - MTO
TM160D	112-160	1250	LV516333	2.955.000	1 - MTS	LV516343	3.543.000	2 - MTO
TM200D	140-200	2000	LV525332	3.718.000	1 - MTS	LV525342	4.664.000	2 - MTO
TM250D	175-250	2500	LV525333	3.829.000	1 - MTS	LV525343	4.808.000	1 - MTS
EasyPact CVS100-250 N (50 kA)								
TM16D	11.2-16	190	LV510470	2.400.000	2 - MTO	LV510480	3.233.000	2 - MTO
TM25D	17.5-25	300	LV510471	2.400.000	1 - MTS	LV510481	3.233.000	2 - MTO
TM32D	22.4-32	400	LV510472	2.400.000	1 - MTS	LV510482	3.139.000	2 - MTO
TM40D	28-40	500	LV510473	2.400.000	1 - MTS	LV510483	3.233.000	2 - MTO
TM50D	35-50	500	LV510474	2.400.000	2 - MTO	LV510484	3.233.000	2 - MTO
TM63D	44.1-63	500	LV510475	2.472.000	1 - MTS	LV510485	3.332.000	2 - MTO
TM80D	56-80	640	LV510476	2.472.000	2 - MTO	LV510486	3.235.000	2 - MTO
TM100D	70-100	800	LV510477	2.472.000	1 - MTS	LV510487	3.332.000	2 - MTO
TM125D	87.5-125	1250	LV516462	3.330.000	1 - MTS	LV516467	4.331.000	2 - MTO
TM160D	112-160	1250	LV516463	3.977.000	1 - MTS	LV516468	5.176.000	2 - MTO
TM200D	140-200	2000	LV525452	4.852.000	1 - MTS	LV525457	5.963.000	2 - MTO
TM250D	175-250	2500	LV525453	4.852.000	1 - MTS	LV525458	5.963.000	2 - MTO

Catatan:

(1) Ics = Service Breaking Capacity, Icu = Ultimate Breaking Capacity.

EasyPact™ EZC

Moulded Case Circuit Breaker 100A 3P/4P



EasyPact EZC100 B/F/N/H dengan 3P/4P

- Aplikasi untuk instalasi listrik dengan kapasitas pemutusan rendah.
- Kapasitas Pemutusan : 7.5 kA s/d 30 kA pada 380/415 VAC.
- Thermal magnetic trip unit, tidak dapat disetel (*non adjustable*).
- Fixed type, front connection.
- Satu ukuran (*frame size*) untuk semua rating.
- Memenuhi standar IEC 60947-2.
- Rated @ 125V DC (1P) dan @ 250V DC (2P in series).

EasyPact	Ir (A)	3P	Harga (Rp) (Sebelum PPN)	SS	4P	Harga (Rp) (Sebelum PPN)	SS
EasyPact EZC100B (7.5 kA @415V AC)							
EZC100B	15	EZC100B3015	945.000	1			
EZC100B	20	EZC100B3020	945.000	1			
EZC100B	25	EZC100B3025	945.000	1			
EZC100B	30	EZC100B3030	945.000	1			
EZC100B	40	EZC100B3040	945.000	1			
EZC100B	50	EZC100B3050	945.000	1			
EZC100B	60	EZC100B3060	1.001.000	1			
EasyPact EZC100F (10 kA @415V AC)							
EZC100F	15	EZC100F3015	1.010.000	1			
EZC100F	20	EZC100F3020	1.010.000	1			
EZC100F	25	EZC100F3025	1.010.000	1			
EZC100F	30	EZC100F3030	1.010.000	1			
EZC100F	40	EZC100F3040	1.010.000	1			
EZC100F	50	EZC100F3050	1.010.000	1			
EZC100F	60	EZC100F3060	1.083.000	1			
EZC100F	75	EZC100F3075	1.083.000	1			
EZC100F	80	EZC100F3080	1.083.000	1			
EZC100F	100	EZC100F3100	1.083.000	1			
EasyPact EZC100N (18 kA @380V AC / 15 kA @415V AC / 5 kA @125V DC; 250V DC)							
EZC100N	15	EZC100N3015	1.269.000	1			
EZC100N	20	EZC100N3020	1.269.000	1	EZC100N4020	2.048.000	1
EZC100N	25	EZC100N3025	1.269.000	1	EZC100N4025	2.048.000	2
EZC100N	30	EZC100N3030	1.269.000	1	EZC100N4030	2.048.000	2
EZC100N	40	EZC100N3040	1.269.000	1	EZC100N4040	2.048.000	2
EZC100N	50	EZC100N3050	1.269.000	1	EZC100N4050	2.048.000	1
EZC100N	60	EZC100N3060	1.385.000	1	EZC100N4060	2.235.000	2
EZC100N	75	EZC100N3075	1.385.000	1	EZC100N4075	2.235.000	2
EZC100N	80	EZC100N3080	1.385.000	1	EZC100N4080	2.235.000	1
EZC100N	100	EZC100N3100	1.385.000	1	EZC100N4100	2.235.000	1
EasyPact EZC100H (30 kA @415V AC / 10 kA @125V DC; 250V DC)							
EZC100H	15	EZC100H3015	1.477.000	1			
EZC100H	20	EZC100H3020	1.477.000	1	EZC100H4020	2.166.000	2
EZC100H	25	EZC100H3025	1.477.000	1	EZC100H4025	2.166.000	2
EZC100H	30	EZC100H3030	1.477.000	1	EZC100H4030	2.166.000	2
EZC100H	35	EZC100H3035	1.477.000	1			
EZC100H	40	EZC100H3040	1.477.000	1	EZC100H4040	2.166.000	1
EZC100H	50	EZC100H3050	1.477.000	1	EZC100H4050	2.166.000	2
EZC100H	60	EZC100H3060	1.568.000	1	EZC100H4060	2.400.000	2
EZC100H	75	EZC100H3075	1.568.000	1	EZC100H4075	2.400.000	2
EZC100H	80	EZC100H3080	1.568.000	1	EZC100H4080	2.400.000	2
EZC100H	100	EZC100H3100	1.568.000	1	EZC100H4100	2.400.000	2

EasyPact™ EZC

Moulded Case Circuit Breaker 250A 2P/3P/4P



EasyPact EZC250 F/N/H

- Aplikasi untuk instalasi listrik dengan kapasitas pemutusan rendah.
- Kapasitas Pemutusan : 18 kA s/d 36 kA pada 380/415 VAC.
- Thermal magnetic trip unit, tidak dapat disetel (*non adjustable*).
- Fixed type, front connection.
- Satu ukuran (*frame size*) untuk semua rating.
- Memenuhi standar IEC 60947-2.
- Rated @ 125V DC (1P) dan @ 250V DC (2P)

EasyPact	Ir (A)	2P	Harga (Rp) (Sebelum PPN)	SS	3P	Harga (Rp) (Sebelum PPN)	SS
EasyPact EZC250F (18 kA @415V AC / 5 kA @125V DC; 250V DC)							
EZC250F	100				EZC250F3100	2.114.000	1
EZC250F	125				EZC250F3125	2.165.000	1
EZC250F	160				EZC250F3160	2.252.000	1
EZC250F	200				EZC250F3200	2.412.000	1
EZC250F	225				EZC250F3225	2.412.000	1
EZC250F	250				EZC250F3250	2.412.000	1
EasyPact EZC250N (25 kA @415V AC / 10 kA @125V DC; 250V DC)							
EZC250N	100				EZC250N3100	2.253.000	1
EZC250N	125				EZC250N3125	2.360.000	1
EZC250N	160				EZC250N3160	2.461.000	1
EZC250N	200				EZC250N3200	3.011.000	1
EZC250N	225				EZC250N3225	3.011.000	2
EZC250N	250				EZC250N3250	3.011.000	1
EasyPact EZC250H (36 kA @415V AC / 30 kA @125V DC; 250V DC)							
EZC250H	100	EZC250H2100	2.484.000	2	EZC250H3100	2.616.000	1
EZC250H	125	EZC250H2125	2.564.000	2	EZC250H3125	2.696.000	1
EZC250H	160	EZC250H2160	2.778.000	2	EZC250H3160	2.926.000	1
EZC250H	200	EZC250H2200	2.975.000	2	EZC250H3200	3.189.000	1
EZC250H	225	EZC250H2225	2.975.000	2	EZC250H3225	3.189.000	2
EZC250H	250	EZC250H2250	2.975.000	2	EZC250H3250	3.189.000	1

EasyPact	Ir (A)	4P	Harga (Rp) (Sebelum PPN)	SS
EasyPact EZC250N (25 kA @415V AC / 10 kA @125V DC; 250V DC)				
EZC250N	100	EZC250N4100	3.099.000	2
EZC250N	125	EZC250N4125	3.238.000	2
EZC250N	160	EZC250N4160	3.362.000	2
EZC250N	200	EZC250N4200	3.735.000	2
EZC250N	250	EZC250N4250	3.735.000	1
EasyPact EZC250H (36 kA @415V AC / 30 kA @125V DC; 250V DC)				
EZC250H	100	EZC250H4100	3.641.000	2
EZC250H	125	EZC250H4125	3.641.000	2
EZC250H	160	EZC250H4160	4.041.000	2
EZC250H	200	EZC250H4200	4.343.000	2
EZC250H	250	EZC250H4250	4.423.000	2

EasyPact™ EZC

Aksesori EasyPact™ EZC 100A | Kontak Bantu & Aksesori

Kontak Bantu

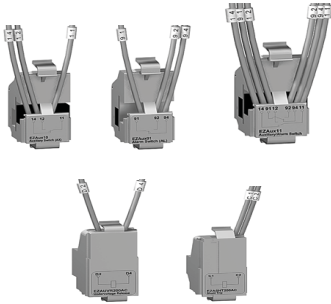

Kontak Bantu	Teg kontrol (V)	Referensi	Harga (Rp) (Sebelum PPN)	SS
Auxiliary Switch (AX)		EZAUX10	407.000	1
Alarm Switch (AL)		EZAUX01		
Auxiliary Switch / Alarm Switch (AX/AL)		EZAUX11	813.000	1
Shunt Trip (SHT)	100-130 VAC	EZASHT100AC	814.000	2
	200-277 VAC	EZASHT200AC	814.000	1
	380-480 VAC	EZASHT380AC	988.000	2
	24 VDC	EZASHT024DC	1.130.000	2
Undervoltage Release (UVR)	200-240 VAC	EZAUVR200AC	2.307.000	1

Aksesori

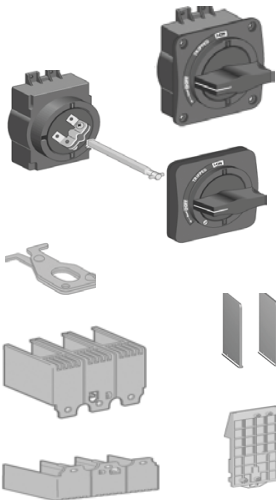

Aksesori EasyPact 100

Aksesori	Qty	Referensi	Harga (Rp) (Sebelum PPN)	SS
Rotary handle	Direct rotary handle	EZAROTDS	905.000	1
	Extended rotary handle	EZAROTE	1.312.000	1
Toggle padlocking device		EZALOCK	147.000	2
Terminal shield (hanya untuk 3P)	2	EZATSHD3P	172.000	2
Phase barrier	2	EZAFASB2	111.000	2
Plug-in	Kit, plug-in base 3P 15 A-50 A	EZAPLUG3L	1.489.000	2
	Kit, plug-in base 3P 60 A-100 A	EZAPLUG3H	1.489.000	2

EasyPact™ EZC

Aksesori EasyPact EZC250 dan EasyPact EZCV250 Kontak Bantu & Aksesori



Kontak Bantu EasyPact 250

Kontak Bantu

Kontak Bantu	Referensi	Harga (Rp) (Sebelum PPN)	SS
Auxiliary Switch (AX)	EZEAX	502.000	1
Alarm Switch (AL)	EZEAL	609.000	2
Auxiliary Switch / Alarm Switch (AX/AL)	EZEAXAL	994.000	1

Kontak Bantu	Teg Kontrol (V)	Referensi	Harga (Rp) (Sebelum PPN)	SS
Shunt Trip	200-240VAC	EZESHT200AC	1.087.000	1
Under Voltage Release (UVR)	200-240 VAC	EZEUVR200AC	6.148.000	2
Under Voltage Release (UVR)	200-240 VAC	EZEUVRN200AC ⁽¹⁾	5.041.000	2

⁽¹⁾ hanya untuk EZC250 4P dan EZCV250 3/4P

Aksesori



Aksesori EasyPact 250

Aksesori	Qty	Referensi	Harga (Rp) (Sebelum PPN)	SS	
Rotary handle		Direct rotary handle	EZEROTDS	933.000	2
		Extended rotary handle	EZEROTE	1.359.000	1
Toggle padlocking device		untuk EZC250 3P	EZELOCK	149.000	2
		untuk EZC250 4P dan EZCV250 3/4P	EZELOCKN	149.000	2
Terminal shield	2	EZETSHD3P	359.000	2	
	2	EZETSHD3PN	332.000	2	
	2	EZETSHD4PN	460.000	2	
Spreader	3	EZESPDR3P	332.000	2	
	4	EZESPDR4P	855.000	2	
Straight extension	3	EZETEX	456.000	2	
Phase barrier	2	EZEFASB2	113.000	2	
Plug-in		Kit, plug-in base 3P 100 A - 250 A 60mm breaker	EZEPLUG3L	3.804.000	2

Life Is On

Schneider
Electric

GoPact MTS

Sakelar Transfer Manual



GoPact Manual Transfer Switch

Perakitan Lengkap & Aksesori



630A Extended Handle
GoPact MTS



160A Extended Handle
GoPact MTS



1250A Extended Handle
GoPact MTS



Komposisi tipikal GoPact MTS

Aksesori sudah termasuk dalam paket produk

Berikut adalah komponen yang termasuk dalam rakitan lengkap:

- 1 Manual Transfer Switch
 - + Inter-Phase Barrier
 - + Output Shorting Link
 - + Auxiliary Contact Kit
 - + Source Separator
 - + Terminal Shroud
 - + Open Execution Shaft
 - + Handle Kit / Handle
 - + Castell Type Lock*
- (* Dapat dibeli terpisah (Opsional))

Perakitan Lengkap

Frame	Rating	Deskripsi	4P Referensi	Harga (Rp) (Sebelum PPN)	SS
Direct Rotary Handle, 415VAC 50/60Hz					
100	63	Manual Transfer Switch 63 amps	GM10D4N0634BDE	Hub. Kami	2
100	100	Manual Transfer Switch 100 amps	GM10D4N1004BDE	Hub. Kami	2
Extended Rotary Handle, 415VAC 50/60Hz					
100	63	Manual Transfer Switch 63 amps	GM10D4N0634BEE	2.989.000	2
100	100	Manual Transfer Switch 100 amps	GM10D4N1004BEE	4.612.000	2
200	125	Manual Transfer Switch 125 amps	GM20D4N1254BEE	4.743.000	2
200	160	Manual Transfer Switch 160 amps	GM20D4N1604BEE	5.945.000	2
200	200	Manual Transfer Switch 200 amps	GM20D4N2004BEE	7.524.000	2
315	250	Manual Transfer Switch 250 amps	GM32D4N2504BEE	8.190.000	2
315	315	Manual Transfer Switch 315 amps	GM32D4N3154BEE	11.413.000	2
630	400	Manual Transfer Switch 400 amps	GM63D4N4004BEE	11.676.000	2
630	630	Manual Transfer Switch 630 amps	GM63D4N6304BEE	12.943.000	2
1000	800	Manual Transfer Switch 800 amps	GM1AD4N8004BEE	22.296.000	2
1000	1000	Manual Transfer Switch 1000 amps	GM1AD4N10H4BEE	35.281.000	2
2000	1250	Manual Transfer Switch 1250 amps	GM2AD4N12H4BEE	37.123.000	2
2000	1600	Manual Transfer Switch 1600 amps	GM2AD4N16H4BEE	48.792.000	2
2000	2000	Manual Transfer Switch 2000 amps	GM2AD4N20H4BEE	80.336.000	2

Aksesori

Frame	Rating	4P Referensi	Harga (Rp) (Sebelum PPN)	SS
Castell Type Lock				
100	63/100	GMSOTHCTL01A	1.768.000	2
200/315/630/1000	125/1000	GMSOTHCTL25A	1.965.000	2
2000	1250/2000	GMSOTHCTL06A	2.137.000	2

GoPact Manual Transfer Switch

Suku Cadang

suku Cadang



Frame	Rating	Deskripsi	4P Referensi	Harga (Rp) (Sebelum PPN)	SS
Handle Kit					
100	63/100	Operating handle, Frame 1, front rotary handle, IP2x	GMSOTHOHK01	427.000	2
200	125/200	Operating handle, Frame 2, front rotary handle, IP2x	GMSOTHOHK02	731.000	2
315	250/315	Operating handle, Frame 3, front rotary handle, IP2x	GMSOTHOHK03	958.000	2
630	400/630	Operating handle, Frame 4, front rotary handle, IP2x	GMSOTHOHK04	988.000	2
1000	630/1000	Operating handle, Frame 5, front rotary handle, IP2x	GMSOTHOHK05	1.548.000	2
2000	1250/2000	Operating handle, Frame 6, front rotary handle, IP2x	GMSOTHOHK06	1.693.000	2



Auxiliary Contact Kit					
100	63/100	Frame 1, 2 NO/NC contacts, ON/OFF indication	GMSAUXCK01	346.000	2
200	125/200	Frame 2, 2 NO/NC contacts, ON/OFF indication	GMSAUXCK02	429.000	2
315	250/315	Frame 3, 2 NO/NC contacts, ON/OFF indication	GMSAUXCK03	424.000	2
630	400/630	Frame 4, 2 NO/NC contacts, ON/OFF indication	GMSAUXCK04	575.000	2
1000	630/1000	Frame 5, 2 NO/NC contacts, ON/OFF indication	GMSAUXCK05	598.000	2
2000	1250/2000	Frame 6, 2 NO/NC contacts, ON/OFF indication	GMSAUXCK06	623.000	2



Open Execution shaft					
100	63/100	for operating handle, Frame 1, shaft length 88.5mm	GMSOTHOES01	101.000	2
200	125/200	for operating handle, Frame 2, shaft length 113mm	GMSOTHOES02	106.000	2
315	250/315	for operating handle, Frame 3, shaft length 108mm	GMSOTHOES03	111.000	2
630	400/630	for operating handle, Frame 4, shaft length 106mm	GMSOTHOES04	121.000	2
1000	630/1000	for operating handle, Frame 5, shaft length 112mm	GMSOTHOES05	162.000	2
2000	1250/2000	for operating handle, Frame 6, shaft length 75-175mm	GMSOTHOES06	330.000	2



Terminal Shroud					
100	63/100	Terminal shrouds, Frame 1, set of 2	GMSISOTS01	99.000	2
200	125/200	Terminal shrouds, Frame 2, set of 2	GMSISOTS02	140.000	2
315	250/315	Terminal shrouds, Frame 3, set of 2	GMSISOTS03	166.000	2
630	400/630	Terminal shrouds, Frame 4, set of 2	GMSISOTS04	255.000	2
1000	630/1000	Terminal shrouds, Frame 5, set of 2	GMSISOTS05	280.000	2
2000	1250/1600	Terminal shrouds, Frame 6, set of 2	GMSISOTS06	289.000	2
2000	2000	Terminal shrouds, Frame 6, set of 2	GMSISOTS0620H	359.000	2



Output Shorting Link					
100	63/100	Output shorting link, Frame 1, top side	GMSCONOSL01T	230.000	2
100	63/100	Output shorting link, Frame 1, bottom side	GMSCONOSL01B	230.000	2
200	125/200	Output shorting link, Frame 2	GMSCONOSL02200	380.000	2
315	250/315	Output shorting link, Frame 3	GMSCONOSL03315	1.128.000	2
630	400/630	Output shorting link, Frame 4	GMSCONOSL04630	1.607.000	2
1000	630/1000	Output shorting link, Frame 5	GMSCONOSL0510H	2.976.000	2
2000	1250	Output shorting link, Frame 6	GMSCONOSL0612H	5.953.000	2
2000	1600	Output shorting link, Frame 6	GMSCONOSL0616H	8.136.000	2
2000	2000	Output shorting link, Frame 6	GMSCONOSL0620H	11.807.000	2



Inter-phase barrier					
200	125/200	Interphase barriers, Frame 2, set of 6	GMSISOPB02	254.000	2
315	250/315	Interphase barriers, Frame 3, set of 6	GMSISOPB03	351.000	2
630	400/630	Interphase barriers, Frame 4, set of 6	GMSISOPB04	384.000	2
1000	630/1000	Interphase barriers, Frame 5, set of 6	GMSISOPB05	422.000	2
2000	1250/1600	Interphase barriers, Frame 6, set of 6	GMSISOPB06	440.000	2
2000	2000	Interphase barriers, Frame 6, set of 6	GMSISOPB0620H	458.000	2



Source separator					
200	125/200	Source separators, Frame 2	GMSISOSS02	118.000	2
315	250/315	Source separators, Frame 3	GMSISOSS03	126.000	2
630	400/630	Source separators, Frame 4	GMSISOSS04	138.000	2
1000	630/1000	Source separators, Frame 5	GMSISOSS05	160.000	2
2000	1250/1600	Source separators, Frame 6	GMSISOSS06	298.000	2
2000	2000	Source separators, Frame 6	GMSISOSS0620H	383.000	2

TransferPacT Active Automatic

Siap memberikan waktu operasional maksimal

- Memenuhi standar IEC 60947-6-1
- Mengoptimalkan ruang panel hingga 30%, menghemat biaya dan meningkatkan efisiensi
- Kecepatan transfer ultra cepat untuk ketersediaan daya yang lebih baik
- Dioperasikan dengan solenoid, dilengkapi pengontrol mikroprosesor bawaan
- Desain tangguh
- Kategori Utilisasi: AC 33B
- Konfigurasi Kutub: 2, 3, 4
- Dapat diskalakan dengan plug-and-play menggunakan 10 modul fungsi
- Konektivitas sesuai standar keamanan siber IEC 62443, Level SL 1



TransferPacT™ Active Automatic



#SourceManagement

TransferPacT Automatic Transfer Switch

TransferPacT Automatic ATS & Active Automatic ATS



TransferPacT adalah saklar transfer canggih yang kompatibel dengan platform EcoStruxure untuk memaksimalkan keandalan dan waktu operasional fasilitas Anda

- Memenuhi standar IEC 60947-6-1
- Dioperasikan dengan solenoid, dilengkapi pengontrol mikroprosesor bawaan
- Waktu transfer cepat <500ms
- Konfigurasi 2, 3, dan 4 kutub dengan rentang arus 32-1600A
- Saklar transfer transisi terbuka dengan tiga posisi
- Tahan terhadap lingkungan ekstrem dengan suhu operasi -25 hingga 70 °C
- Kategori Utilisasi: AC 33B
- Telah diuji untuk diskriminasi total dengan pemutus sirkuit ComPacT NSXm untuk integrasi tanpa gangguan
- Dapat diskalakan dengan plug-and-play menggunakan 10 modul fungsi
- Terhubung dengan standar keamanan siber IEC 62443, Level SL1

TransferPacT Automatic ATS

Frame	Rating (Amps)	2P Referensi	Harga (Rp) (Sebelum PPN)	SS	3P Referensi	Harga (Rp) (Sebelum PPN)	SS	4P Referensi	Harga (Rp) (Sebelum PPN)	SS
TA10	32	TA10D2S0323TPE	10.301.000	2	TA10D3S0324TPE	10.518.000	2	TA10D4S0324TPE	10.844.000	2
	40	TA10D2S0403TPE	10.301.000	2	TA10D3S0404TPE	10.518.000	2	TA10D4S0404TPE	10.844.000	2
	50	TA10D2S0503TPE	10.301.000	2	TA10D3S0504TPE	10.518.000	2	TA10D4S0504TPE	10.844.000	2
	63	TA10D2S0633TPE	10.988.000	2	TA10D3S0634TPE	11.219.000	2	TA10D4S0634TPE	11.566.000	2
	80	TA10D2S0803TPE	11.141.000	2	TA10D3S0804TPE	11.331.000	2	TA10D4S0804TPE	11.683.000	2
	100	TA10D2S1003TPE	18.084.000	2	TA10D3S1004TPE	18.466.000	2	TA10D4S1004TPE	19.037.000	2
TA16	125				TA16D3S1254TPE	21.868.000	2	TA16D4S1254TPE	22.545.000	2
	160				TA16D3S1604TPE	24.973.000	2	TA16D4S1604TPE	25.746.000	2
TA25	200				TA25D3S2004TPE	34.349.000	2	TA25D4S2004TPE	35.410.000	2
	250				TA25D3S2504TPE	34.692.000	2	TA25D4S2504TPE	35.765.000	2
TA63	320				TA63D3S3204TPE	46.364.000	2	TA63D4S3204TPE	47.798.000	2
	400				TA63D3S4004TPE	47.883.000	2	TA63D4S4004TPE	49.361.000	2
	500				TA63D3S5004TPE	52.294.000	2	TA63D4S5004TPE	53.910.000	2
	630				TA63D3S6304TPE	53.861.000	2	TA63D4S6304TPE	55.528.000	2

TransferPacT Active Automatic ATS

Frame	Rating (Amps)	2P Referensi	Harga (Rp) (Sebelum PPN)	SS	3P Referensi	Harga (Rp) (Sebelum PPN)	SS	4P Referensi	Harga (Rp) (Sebelum PPN)	SS
TA10	32	TA10D2L0323TPE	17.668.000	2	TA10D3L0324TPE	18.040.000	2	TA10D4L0324TPE	18.597.000	2
	40	TA10D2L0403TPE	18.043.000	2	TA10D3L0404TPE	18.432.000	2	TA10D4L0404TPE	18.993.000	2
	50	TA10D2L0503TPE	18.212.000	2	TA10D3L0504TPE	18.593.000	2	TA10D4L0504TPE	19.168.000	2
	63	TA10D2L0633TPE	19.208.000	2	TA10D3L0634TPE	19.613.000	2	TA10D4L0634TPE	20.220.000	2
	80	TA10D2L0803TPE	21.001.000	2	TA10D3L0804TPE	21.442.000	2	TA10D4L0804TPE	22.107.000	2
	100	TA10D2L1003TPE	21.168.000	2	TA10D3L1004TPE	21.613.000	2	TA10D4L1004TPE	22.281.000	2
TA16	125				TA16D3L1254TPE	25.145.000	2	TA16D4L1254TPE	25.924.000	2
	160				TA16D3L1604TPE	28.249.000	2	TA16D4L1604TPE	29.137.000	2
TA25	200				TA25D3L2004TPE	37.045.000	2	TA25D4L2004TPE	38.192.000	2
	250				TA25D3L2504TPE	37.419.000	2	TA25D4L2504TPE	38.574.000	2
TA63	320				TA63D3L3204TPE	50.355.000	2	TA63D4L3204TPE	51.902.000	2
	400				TA63D3L4004TPE	51.797.000	2	TA63D4L4004TPE	53.398.000	2
	500				TA63D3L5004TPE	54.386.000	2	TA63D4L5004TPE	56.068.000	2
	630				TA63D3L6304TPE	56.017.000	2	TA63D4L6304TPE	57.751.000	2
TA1A	800							TA1AD4L8004TPE	117.642.000	2
	1000							TA1AD4L10H4TPE	118.819.000	2
	1250							TA1AD4L12H4TPE	119.204.000	2
	1600							TA1AD4L16H4TPE	120.396.000	2

TransferPacT Automatic Transfer Switch

TransferPacT Automatic Aksesori



Barrier



Shield



Bar



Function Modules



TPCCIF01



TPCOTH37



TPCCIF02



TPCCIF04



Auxiliary Contact

Aksesori

Deskripsi	Referensi	Harga (Rp) <i>(Sebelum PPN)</i>	SS
Function Module			
ModBus RS485	TPCCOM16	3.794.000	2
Voluntary control	TPCDIO08	1.361.000	2
24Vdc pulse	TPCDIO10	1.434.000	2
24Vdc constant	TPCDIO11	1.373.000	2
220Vac constant	TPCDIO13	1.418.000	2
Dry contact	TPCDIO14	1.363.000	2
Ext24VDC CAN	TPCDIO15	1.139.000	2
GS delay Alarm	TPCDIO17	2.008.000	2
LS AW output	TPCDIO05	1.400.000	2
TI ST input	TPCDIO07	1.360.000	2
Insulation Accessory			
barrier for R2	TPSISO29	224.000	2
shield for R1	TPSISO30	265.000	2
shield for R2	TPSISO31	285.000	2
terminal shield for Frame 630A	TPSISO42	555.000	2
Interphase barriers for Frame 250A and 630A	TPSISO65	243.000	2
Insulating screen for Frame 250A	TPSISO66	401.000	2
Insulating screen for Frame 630A	TPSISO67	701.000	2
Connection Accessory			
Bars for Ruby 1	TPSCON35	773.000	2
Bars for Ruby 2	TPSCON36	739.000	2
Aux			
Auxiliary contact for source position for Frame 100&160	TPSAUX32	519.000	2
Auxiliary contact for OFF position for Frame 100&160	TPSAUX33	515.000	2
auxiliary contact for source for Frame 250A, Frame 630A	TPSAUX43	329.000	2
auxiliary contact for OFF for Frame 250A, Frame 630A	TPSAUX44	383.000	2
Display Module			
External HMI	TPCCIF04	3.177.000	2
LCD display	TPCCIF01	2.369.000	2
Spare parts			
Accessory handle for Frame 250A and 630A	TPSOTH69	2.545.000	2

Life Is On

Schneider
Electric

Industrial Plug Socket

Performa tinggi sesuai dengan standar
IEC serta mudah diinstal



Plug & Socket

Gambar	Arus Pengenal	Jumlah Kutub	Tegangan Pengenal	Referensi	Pak	Harga (Sebelum PPN)
Socket Panel IP67						
	16 A	2P + Pe	200 - 250V	PKF16F723	10	265.100
		3P + Pe	380 - 415V	PKF16F734	10	303.000
		3P + N + Pe	380 - 415V	PKF16F735	10	331.200
	32 A	2P + Pe	200 - 250V	PKF32F723	8	391.200
		3P + Pe	380 - 415V	PKF32F734	8	414.100
		3P + N + Pe	380 - 415V	PKF32F735	7	452.300
Plug Wander IP44						
	16 A	2P + Pe	200 - 250V	PKE16M423	10	144.700
		3P + Pe	380 - 415V	PKE16M434	10	159.700
		3P + N + Pe	380 - 415V	PKE16M435	10	196.400
	32 A	2P + Pe	200 - 250V	PKE32M423	10	213.600
		3P + Pe	380 - 415V	PKE32M434	10	224.800
		3P + N + Pe	380 - 415V	PKE32M435	10	258.300
Socket Wander IP44						
	16 A	2P + Pe	200 - 250V	PKF16M423	10	211.700
		3P + Pe	380 - 415V	PKF16M434	10	229.600
		3P + N + Pe	380 - 415V	PKF16M435	10	260.800
	32 A	2P + Pe	200 - 250V	PKF32M423	10	284.000
		3P + Pe	380 - 415V	PKF32M434	10	286.300
		3P + N + Pe	380 - 415V	PKF32M435	8	343.500

IP 44

Gambar	Arus Pengenal	Jumlah Kutub	Tegangan Pengenal	Warna	Referensi	Harga (Sebelum PPN)
 Wall Mounted Socket IP 44	16 A	2P + Pe	200 - 250V	Biru	83104	247.800
		3P + Pe	380 - 415V	Merah	83108	327.800
		3P + N + Pe	380 - 415V	Merah	83109	451.500
	32 A	2P + Pe	200 - 250V	Biru	83116	393.600
		3P + Pe	380 - 415V	Merah	83120	480.000
		3P + N + Pe	380 - 415V	Merah	83121	480.000

IP 67

Gambar	Arus Pengenal	Jumlah Kutub	Tegangan Pengenal	Warna	Referensi	Harga (Sebelum PPN)
 Mobile Plug IP 67	16 A	2P + Pe	200 - 250V	Biru	PKE16M723	288.700
		3P + Pe	380 - 415V	Merah	PKE16M734	313.500
		3P + N + Pe	380 - 415V	Merah	PKE16M735	321.400
	32 A	2P + P	200 - 250V	Biru	PKE32M723	384.800
		3P + Pe	380 - 415V	Merah	PKE32M734	421.200
		3P + N + Pe	380 - 415V	Merah	PKE32M735	452.300

Sakelar S56

Gambar	Arus Pengenal	Jumlah Sakelar	Tegangan Pengenal	Referensi	Pak	Harga (Sebelum PPN)
	10	1	250	S56SW110GY	24	464.000
	20	1	250	S56SW120GY	24	517.000
	32	1	250	S56SW132GY	24	580.100
	20	2	500	S56SW220GY	24	918.800
	10	3	500	S56SW310GY	24	670.700
	20	3	500	S56SW320GY	24	692.600

Life Is On

Schneider
Electric

Easy Tesys

Kontaktor dengan kemampuan beroperasi **1,4 juta kali**

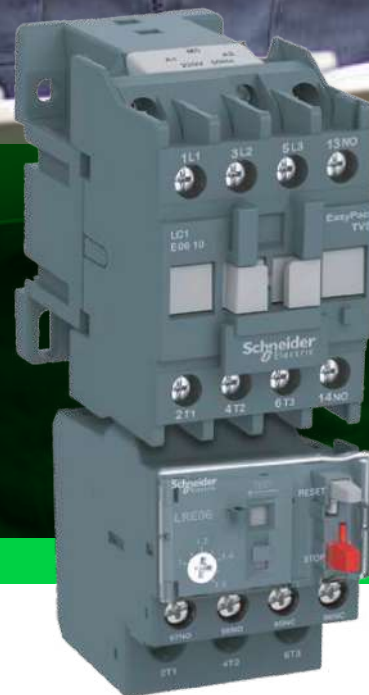

TeSys Control Easy TeSys

Kontaktor 3 kutub dari 6A sampai dengan 630A

Kontrol AC



LC1E06 ●●●●●



LC1E65 ●●



LC1E120 ●●



LC1E300 ●●

Arus AC-1 (A)	Daya Motor AC-3 380/400 V (kW)	Arus AC-3 (A)	Kontak Bantu		Referensi	Harga (Rp) (Sebelum PPN)	SS
			N/O	N/C			
Koneksi Standard							
20	2.2	6	1	0	LC1E0610M7	249.000	1
20	2.2	6	0	1	LC1E0601M7	249.000	2
25	4	9	1	0	LC1E0910M7	273.000	1
25	4	9	0	1	LC1E0901M7	273.000	1
25	5.5	12	1	0	LC1E1210M7	299.000	1
25	5.5	12	0	1	LC1E1201M7	299.000	2
32	7.5	18	1	0	LC1E1810M7	407.000	1
32	7.5	18	0	1	LC1E1801M7	407.000	1
36	11	25	1	0	LC1E2510M7	524.000	1
36	11	25	0	1	LC1E2501M7	524.000	2
50	15	32	1	0	LC1E3210M7	735.000	1
50	15	32	0	1	LC1E3201M7	735.000	1
50	18.5	38	1	0	LC1E3810M7	906.000	2
50	18.5	38	0	1	LC1E3801M7	906.000	2
60	18.5	40	1	1	LC1E40M7	1.232.000	1
70	22	50	1	1	LC1E50M7	1.397.000	2
80	30	65	1	1	LC1E65M7	2.053.000	1
110	37	80	1	1	LC1E80M7	2.200.000	1
120	45	95	1	1	LC1E95M7	2.658.000	1
150	55	120	1	1	LC1E120M5	3.443.000	1
200	75	160	1	1	LC1E160M5	4.558.000	1
250	90	200	-	-	LC1E200M5	8.591.000	1
300	132	250	-	-	LC1E250M5	9.925.000	2
320	160	300	-	-	LC1E300M5	21.013.000	2
500	200	400	-	-	LC1E400M7	27.322.000	2
700	250	500	-	-	LC1E500M7	32.536.000	2
1000	335	630	-	-	LC1E630M7	32.598.000	2

Catatan :

- Coil **M7** ataupun **M5** adalah untuk aplikasi pada **220 V AC**.
- Untuk tipe tegangan coil lainnya silakan hubungi Customer Care Center kami.
- Berikut adalah kode coil untuk tegangan lain. **Harga dapat berbeda** dari yang tertera di atas

Koil	Koil	24	48	110	220	230	240	380	415	440
LC1E06-300	50 Hz	B5	E5	F5	M5	-	U5	Q5	N5	R5
	60 Hz	B6	-	F6	M6	-	-	Q6	-	R6
LC1E06-95	50/60Hz	B7	E7	F7	M7	P7	-	Q7	-	-
LC1E400-630	50/60Hz	-	E7	F7	M7	-	U7	Q7	N7	-



LAEN20



LAETSD

Kontak Bantu Seketika

Jumlah Kontak	N/O	N/C	Referensi	Harga (Rp) (Sebelum PPN)	SS
Kontak Bantu Seketika Mounting Depan					
2	1	1	LAEN11	76.000	1
4	2	2	LAEN22	141.000	2
2	2	0	LAEN20	80.000	2

Kontak Blok Tunda Waktu

Tipe	Setting Waktu	N/O	N/C	Referensi	Harga (Rp) (Sebelum PPN)	SS
Kontak Blok Tunda Waktu	1 s/d 30 s	1	1	LAETSD	1.074.000	2

TeSys Protect | LRE

Relai Termal Beban Lebih Easy TeSys

Relay beban lebih termal untuk Easy TeSys



LRE02



LRE355



LRE485

Setting Arus (A)	Untuk kontaktor LC1	Referensi	Harga (Rp) <i>(Sebelum PPN)</i>	SS
Koneksi Standard				
0.16 ... 0.25	E06 ... E38	LRE02	350.000	2
0.25 ... 0.40	E06 ... E38	LRE03	350.000	2
0.40 ... 0.63	E06 ... E38	LRE04	350.000	2
0.63 ... 1	E06 ... E38	LRE05	350.000	2
1 ... 1.6	E06 ... E38	LRE06	350.000	1
1.6 ... 2.5	E06 ... E38	LRE07	350.000	1
2.5 ... 4	E06 ... E38	LRE08	350.000	1
4 ... 6	E06 ... E38	LRE10	353.000	1
5.5 ... 8	E09 ... E38	LRE12	355.000	1
7 ... 10	E09 ... E38	LRE14	357.000	1
9 ... 13	E12 ... E38	LRE16	370.000	1
12 ... 18	E18 ... E38	LRE21	398.000	1
16 ... 24	E25 ... E38	LRE22	410.000	1
23 ... 32	E25 ... E38	LRE32	523.000	1
30 ... 40	E40 ... E95	LRE355	931.000	1
37 ... 50	E50 ... E95	LRE357	1.157.000	2
48 ... 65	E65 ... E95	LRE359	1.299.000	2
55...70	E80 ... E95	LRE361	1.341.000	2
80...104	E95	LRE365	2.143.000	2
84...135	E120..E160	LRE482	2.947.000	2
124...198	E200	LRE483	7.752.000	2
174...279	E250...E400	LRE485	7.752.000	2
259...414	E300 ...E400	LRE487	7.782.000	2
321 ... 513	E500	LRE488	7.833.000	2
394 ... 630	E630	LRE489	7.833.000	2

Life Is On

Schneider
Electric

Tesys Deca

Solusi starter motor inovatif
dan terkoneksi



TeSys Deca

Kontaktor 3 kutub dari 9A sampai dengan 150A

Kontrol AC



LC1D09M7



LC1D65AM7



LC1D95●●

AC1 (A)	AC-3 380/415 V		Kontak Bantu		Referensi	Koil AC		Koil DC	
	(kW)	(A)	N/O	N/C		Harga (Rp) (Sebelum PPN)	SS	Harga (Rp) (Sebelum PPN)	SS
Koneksi Standard									
25	4	9	1	1	LC1D09●●	386.000	1	1.129.000	1
25	5,5	12	1	1	LC1D12●●	456.000	1	1.206.000	1
32	7,5	18	1	1	LC1D18●●	596.000	1	1.615.000	1
40	11	25	1	1	LC1D25●●	815.000	1	2.181.000	1
50	15	32	1	1	LC1D32●●	1.109.000	1	3.151.000	1
50	18,5	38	1	1	LC1D38●●	1.350.000	1	3.352.000	2
Koneksi EverLink									
60	18.5	40	1	1	LC1D40A●●	1.878.000	1	4.475.000	2
80	22	50	1	1	LC1D50A●●	2.262.000	1	4.735.000	2
80	30	65	1	1	LC1D65A●●	3.159.000	1	5.127.000	2
Koneksi Standard									
125	37	80	1	1	LC1D80●●	3.217.000	1	5.726.000	2
125	45	95	1	1	LC1D95●●	3.963.000	1	7.068.000	2
200	55	115	1	1	LC1D115●●	5.053.000	1	8.434.000	2
200	75	150	1	1	LC1D150●●	7.450.000	1	11.465.000	2

Catatan :

- Gantikan kode ●● pada referensi untuk tegangan kontrol koil sesuai dengan tabel.
- Alternatif tegangan koil DC dapat menggunakan TeSys D Green
- Harga di atas hanya berlaku untuk koil M7 (220 VAC) dan BD (24 VDC)

Koil	220 V AC	24 V DC
Kode ●●	M7	BD

- Untuk tipe tegangan koil lainnya, silakan hubungi Customer Care Center kami.
- Berikut adalah kode koil untuk tegangan lain. **Harga dapat berbeda** dari yang tertera di atas

Tegangan AC (Volts)	24	48	110	230	380
Kode Koil	B7	E7	F7	P7	Q7
Tegangan DC (Volts)	48	110	125	220	
Kode Koil	ED	FD	GD	MD	

TeSys Control

Aksesori Kontaktor Tesys Control - K dan Deca



LA1KN20



LADN11



LADT2

Kontak Bantu Seketika

Jumlah Kontak	N/O	N/C	Referensi	Harga (Rp) (Sebelum PPN)	SS
Untuk kontaktor TeSys K					
2	2	-	LA1KN20	133.000	2
	-	2	LA1KN02	133.000	2
	1	1	LA1KN11	133.000	2
4	4	-	LA1KN40	208.000	2
	3	1	LA1KN31	208.000	2
	2	2	LA1KN22	208.000	1
	1	3	LA1KN13	218.000	2
	-	4	LA1KN04	208.000	2
Untuk kontaktor TeSys Deca mounting depan					
2	1	1	LADN11	177.000	1
	2	-	LADN20	177.000	1
	-	2	LADN02	177.000	1
4	2	2	LADN22	316.000	1
	1	3	LADN13	314.000	2
	4	-	LADN40	314.000	1
	-	4	LADN04	314.000	1
	3	1	LADN31	314.000	1
Untuk kontaktor TeSys Deca (koil AC) mounting samping					
2	1	1	LAD8N11	248.000	1
	2	-	LAD8N20	246.000	2
	-	2	LAD8N02	249.000	2

Kontak Blok Tunda Waktu

Tipe	Setting Waktu	Referensi	Harga (Rp) (Sebelum PPN)	SS
Tunda hidup	0.3 s/d 3 s	LADT0 ⁽¹⁾	1.398.000	1
	1 s/d 30 s	LADT2 ⁽¹⁾	1.398.000	1
	10 s/d 180 s	LADT4	1.398.000	2
Tunda mati	1 s/d 30 s	LADS2	1.398.000	1
	0.3 s/d 3 s	LADR0 ⁽²⁾	1.398.000	2
	1 s/d 30 s	LADR2	1.398.000	2
	10 s/d 180 s	LADR4	1.398.000	2

Catatan :

(1) dengan penambahan skala waktu dari 0.1 hingga 0.6 detik

(2) dengan waktu peralihan (switching time) 40ms + 15ms di antara terbukanya kontak N/C dan tertutupnya kontak N/C

Koil Cadangan AC Untuk Kontaktor 3 Atau 4 Kutub

Untuk Tipe Kontraktor	110 V	220 V	Harga (Rp) (Sebelum PPN)	SS
LC1D09●● s/d LC1D38●● LC1DT20●● s/d LC1DT40●●	LXD1F7	LXD1M7	539.000	2
LC1D40A●● s/d LC1D65A●● LC1DT60A●● s/d LC1DT80A●●	LXD3F7	LXD3M7	1.070.000	2
LC1D80●● s/d LC1D95●●	LX1D6F5	LX1D6M5	1.428.000	2

TeSys Control

Aksesori Kontaktor TeSys Deca

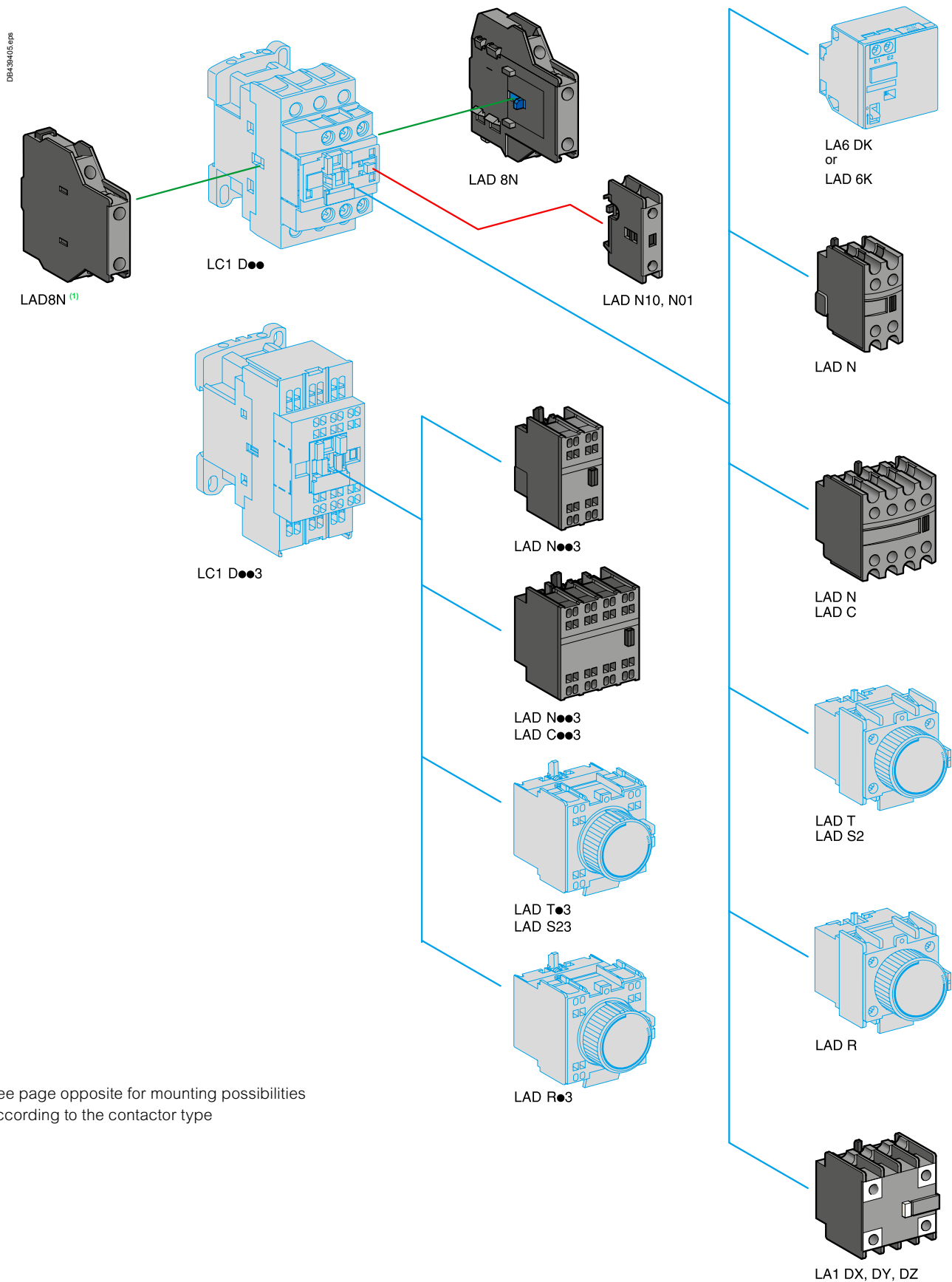

See page opposite for mounting possibilities according to the contactor type

(1) No left side mounting on Deca green contactors.

TeSys Protect | LRD

Relay Beban Lebih Termal TeSys Deca (Kelas 10A)

Relay beban lebih termal untuk kontaktor TeSys Deca



LRD08



LRD35



LRD33

Setting Arus (A)	Untuk kontaktor LC1	Referensi	Harga (Rp) (Sebelum PPN)	SS
Koneksi Standard				
0.10 ... 0.16	D09 ... D38	LRD01	555.000	2
0.16 ... 0.25	D09 ... D38	LRD02	555.000	2
0.25 ... 0.40	D09 ... D38	LRD03	555.000	1
0.40 ... 0.63	D09 ... D38	LRD04	555.000	1
0.63 ... 1	D09 ... D38	LRD05	555.000	1
1 ... 1.6	D09 ... D38	LRD06	555.000	1
1.6 ... 2.5	D09 ... D38	LRD07	555.000	1
2.5 ... 4	D09 ... D38	LRD08	555.000	1
4 ... 6	D09 ... D38	LRD10	555.000	1
5.5 ... 8	D09 ... D38	LRD12	555.000	1
7 ... 10	D09 ... D38	LRD14	560.000	1
9 ... 13	D12 ... D38	LRD16	560.000	1
12 ... 18	D18 ... D38	LRD21	630.000	1
16 ... 24	D25 ... D38	LRD22	649.000	1
23 ... 32	D25 ... D38	LRD32	831.000	1
30 ... 38	D32 ... D38	LRD35	850.000	1

Koneksi EverLink				
9 ... 13	D40A ... D65A	LRD313	1.498.000	2
12 ... 18	D40A ... D65A	LRD318	1.498.000	2
17 ... 25	D40A ... D65A	LRD325	1.498.000	1
23 ... 32	D40A ... D65A	LRD332	1.498.000	1
30 ... 40	D40A ... D65A	LRD340	1.607.000	1
37 ... 50	D40A ... D65A	LRD350	1.719.000	1
48 ... 65	D50A ... D65A	LRD365	1.907.000	1

Koneksi Standard				
55 ... 70	D80 ... D95	LRD3361	2.436.000	1
63 ... 80	D80 ... D95	LRD3363	2.482.000	1
80 ... 104	D80 ... D95	LRD3365	2.508.000	1
80 ... 104	D115 ... D150	LRD4365	4.247.000	1
95 ... 120	D115 ... D150	LRD4367	4.288.000	1
110 ... 140	D150	LRD4369	4.614.000	2

Aksesori

Setting Arus (A)	Untuk TOR dan kontaktor	Referensi	Harga (Rp) (Sebelum PPN)	SS
Terminal Block untuk mounting/kabel	LRD01 ... D35	LAD7B106	229.000	1
	LRD33●●	LA7D3064	1.271.000	2
	LRD3●●	LAD96560	237.000	1

Life Is On

Schneider
Electric

EasyLogic

Power Meter yang Lengkap dan Andal



Digital Meter

Ampere Meter, Volt Meter, dan Frekuensi Meter Digital



METSEDM3110



METSEDM1210



METSEDM1310

Data Teknis

Kelas akurasi : 0.5 untuk Tegangan dan Arus, 0.2 untuk Frekuensi
 Standard : IEC6100042, IEC6100044, IEC6100045, dan IEC60060
 Display : 4 digit LED
 Suhu operasi : 10 C s/d 60 C
 Dimensi : 96 x 96, cutout 92 x 92
 Ratio CT & PT : Adjustable

Fasa	Operating Range	Referensi	Harga (Rp) (Sebelum PPN)	SS
Ampere Meter Digital				
1	50mA-6A	METSEDM1110	567.000	1
3	50mA-6A	METSEDM3110	693.000	2

Volt Meter Digital				
1	44-480 VAC	METSEDM1210	557.000	1
3	80-480 VAC _{LL}	METSEDM3210	641.000	1

Frekuensi Meter Digital				
1	20-100 Hz	METSEDM1310	799.000	2

Digital Meter dan Power Meter

Digital Meter Seri DM6200H dan Power Meter Seri PM2000

Spesifikasi Umum

- Mengukur parameter kelistrikan standar (Arus, Tegangan, Frekuensi, Faktor Daya, Daya, dan Energi).
- Dilengkapi dengan LED atau LCD untuk memudahkan pembacaan.
- Dimensi : 96 x 96, cutout : 92 x 92
- Adjustable CT & PT Ratio

Spesifikasi	DM6200H	PM2120	PM2220	PM2230
				
Pengukuran				
Arus (Fasa dan Netral)	✓	✓	✓	✓
Tegangan (Rata-rata, Fasa-Fasa, dan Fasa-Netral)	✓	✓	✓	✓
Frekuensi	✓	✓	✓	✓
Faktor Daya (Rata-rata dan per Fasa)	✓	✓	✓	✓
Daya (Total dan per Fasa)		✓	✓	✓
Energi (Aktif, Reaktif, Nyata)		✓	✓	✓
THD (Arus dan Tegangan)		✓	✓	✓
Kelas akurasi				
Arus	1	0,5	0,5	0,5
Tegangan	1	0,5	0,5	0,5
Daya Aktif		0,5	0,5	0,5
Daya Reaktif		1	1	1
Energi Aktif		1	1	0,5S
Energi Reaktif		1	1	1
Spesifikasi Lain				
LCD	LED 7-Segment	LED 7-Segment	Monochrome	Monochrome
Resolusi LCD	-	-	128 x 128	128 x 128
Modbus Serial (RS485)	✓	✓	✓	✓

Deskripsi	Nama Produk	Referensi	Harga (Rp) (Sebelum PPN)	SS
Digital Meter Seri 6200 H dengan Komunikasi	DM6200H	METSEDM6200HCL10RS	1.934.000	2
Power Meter Seri 2000 LED dengan Komunikasi	PM2120	METSEPM2120	4.020.000	2
Power Meter Seri 2000 LCD dengan Komunikasi	PM2220	METSEPM2220	6.221.000	2
Power Meter Seri 2000 LCD dengan Komunikasi dan Akurasi 0.5S	PM2230	METSEPM2230	6.583.000	2

Life Is On

Schneider
Electric



Harmony Push Button & Signaling

Push Button tahan hingga **10 juta kali klik**

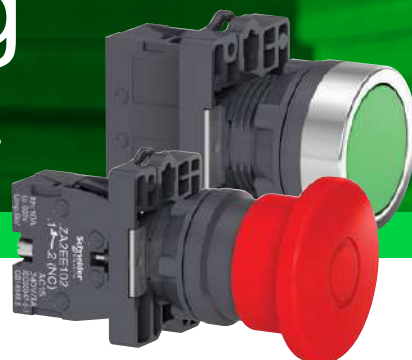

Produk Relay Schneider memiliki ketahanan mekanis hingga **100 ribu kali cycle**, serta dilengkapi dengan tombol tes manual dan lampu status LED



Harmony XB5

- Kualitas standar internasional, indeks proteksi yang tinggi mencapai IP66.
- Sertifikasi lengkap antara lain : IEC, UL, CE, CSA, CCC, NEMA, BV, RINA, GL, dan lain-lain.
- 100.000 jam operasional untuk pilot light dan 10.000.000 kali durabilitas mekanik push button
- Pemasangan yang mudah dan klip metal memastikan push button tidak mudah terlepas.



Harmony XB5, Diameter 22 mm, IP66

Produk	Referensi	Keterangan	Warna	Harga (Sebelum PPN)
Push Button	XB5AA●●	1 N/O (1 N/C untuk merah)	Hitam(21), Hijau(31), Merah(42), Kuning(51), Biru(61)	90.900
Pilot Light	XB5AVM●	230...240V AC	Putih(1), Hijau(3), Merah(4), Jingga(5), Biru(6)	129.000
Selector Switch	XB5AD21	2 Posisi - 1 N/O	Hitam	145.000
Emergency Stop	XB5AS8442	Latching Turn To Release Ø40 mm - 1 N/C	Merah	185.000

Catatan: Gantikan kode ●● dan ● pada referensi dengan kode warna.

Harmony XA2

Kualitas Produk yang OK dengan harga yang Pas

- Performa produk yang dapat diandalkan, IP54 untuk push button dan IP40 untuk pilot light
- Ketahanan dan kualitas yang teruji, standar internasional IEC dan CCC

Mudah dipilih, Mudah digunakan

- Fungsi-fungsi dasar sesuai kebutuhan aplikasi
- Pemasangan yang mudah dan cepat, push button bisa ditambahkan kontak N/O atau N/C

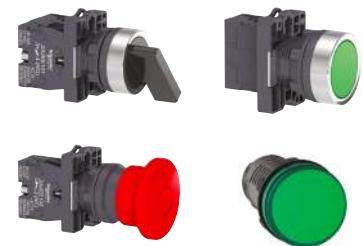

Harmony XA2, Diameter 22 mm, IP54 & IP40

Produk	Referensi	Keterangan	Warna	Harga (Sebelum PPN)
Push Button	XA2EA●●	1 N/O (1 N/C untuk merah)	Putih(11), Hitam(21), Hijau(31), Merah(42), Kuning(51), Biru(61)	46.400
Pilot Light	XA2EVM●LC	220V AC	Putih(1), Hijau(3), Merah(4), Jingga(5), Biru(6)	37.000
Selector Switch	XA2ED21	2 Posisi - 1 N/O	Hitam	62.400
Emergency Stop	XA2ES542	Turn To Release Ø40 mm - 1 N/C	Merah	84.900

Catatan: Gantikan kode ●● dan ● pada referensi dengan kode warna.

ABL2 Switch Mode Power Supplies

- 100 240 input VAC, satu fasa
- Output 24VDC
- 7 opsi daya dalam kisaran 35-350 W
- Rangkaian lengkap sesuai dengan standar EMC
- Sesuai dengan standar CE dan RoHS
- Tegangan output, +/- 10% dapat disesuaikan
- Indikator LED hijau di terminal output
- Produk ini dilengkapi dengan penutup pelindung plastik untuk terminal block sebagai standar.
- Lubang pemasangan yang mudah
- Pemilihan voltase input 115 / 230V AC
- Adaptasi otomatis untuk model 35 / 50W
- Manual dengan sakelar untuk model 100-350W



Tegangan Input (V)	Tegangan Output (V DC)	Daya Nominal (Watt)	Arus Nominal (A)	Filter	Referensi	Harga (Sebelum PPN)
Single-phase (N-L1) atau phase-to-phase (L1-L2)						
AC 100...240 (1) single-phase wide range	24 VDC	35 watt	1.5	Automatic	ABL2REM24015K	429.098
		50 watt	2.2	Automatic	ABL2REM24020K	479.362
		100 watt	4.5	Manual	ABL2REM24045K	630.051
		150 watt	6.5	Manual	ABL2REM24065K	711.936
AC 100...120 AC 200...240 (2) single-phase	24 VDC	200 watt	8.3	Manual	ABL2REM24085K	1.006.722
		250 watt	10.5	Manual	ABL2REM24100K	1.151.849
		350 watt	14.6	Manual	ABL2REM24150K	1.214.164

Aksesori Mounting

Deskripsi	Untuk Power Supply	Pak	Referensi	Harga (Sebelum PPN)
Braket Instalasi empat pojokan	Direkomendasikan untuk Baut M4*6mm atau M4*8mm	40	ABL2K01	Hub Kami
35MM Braket utk DIN Rail 35mm	ABL2REM24085K/100K/150K: tiap produk butuh 4	5	ABL2K02	Hub Kami
	ABL2REM24200K/250K/350K butuh 2			

Relay

RXM-AB

• Miniatur Relay

Dilengkapi tombol tes manual

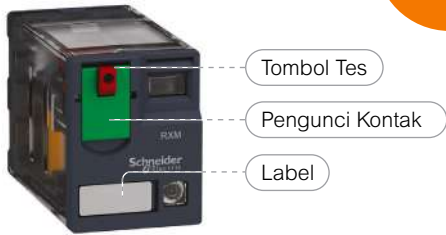

RXM-LB

• Miniatur Relay



- Bentuk lebih ringkas
- Kemudahan dalam pemasangan/ penggantian 1 to 1 replacement.
- Tersedia 2/4 kontak CO, 24 VDC & 220 VAC

Referensi	Jumlah Pin	Jumlah Kontak (CO)	Arus	LED	Harga (Sebelum PPN)
RXM2AB1●●	8	2	12	-	131.000
RXM2AB2●●	8	2	12	Ya	147.500
RXM4AB1●●	14	4	6	-	122.500
RXM4AB2●●	14	4	6	Ya	147.500

Catatan: Gantikan kode ●● pada referensi untuk tegangan kontrol koil sesuai tabel dibawah.

Koil	24 V DC	230 V AC
Kode ●●	BD	P7

- Untuk tipe tegangan koil lainnya silakan menghubungi customer care center kami.
- Dilengkapi dengan tombol tes manual.

Referensi	Jumlah Pin	Jumlah Kontak (CO)	Arus	LED	Harga (Sebelum PPN)
RXM2LB1●●	8	2	5	-	73.900
RXM2LB2●●	8	2	5	Ya	76.700
RXM4LB1●●	14	4	3	-	84.900
RXM4LB2●●	14	4	3	Ya	91.000

Catatan: Gantikan kode ●● pada referensi untuk tegangan kontrol koil sesuai tabel dibawah.

Koil	24 V DC	230 V AC
Kode ●●	BD	P7

- Untuk tipe tegangan koil lainnya silakan menghubungi customer care center kami.
- Dilengkapi dengan tombol tes manual

RXM-AB

• Socket



Logic style socket separated termination

Referensi	Untuk Tipe Relay	Terminal	Koneksi	Harga (Sebelum PPN)
RXZE2S108M	RXM2	Terpisah	Konektor	60.200
RXZE2S114M	RXM4	Terpisah	Konektor	68.100

RXM-LB

• Socket



Referensi	Untuk Tipe Relay	Terminal	Koneksi	Harga (Sebelum PPN)
RXZE1M2C	RXM2LB	Tercampur	Screw Clamp	42.000
RXZE1M4C	RXM4LB	Tercampur	Connector	51.300

Life Is On

Schneider
Electric



Uninterruptible Power Supply (UPS) 1 Fasa

Melindungi perangkat elektronik Anda dari gangguan listrik



Uninterruptible Power Supply (UPS) 1 Fasa

UPS 1 Fasa 0.5 - 3 kVA | Line Interactive

Melindungi perangkat elektronik Anda dari gangguan listrik

- Range **500VA - 3 kVA**
- Cadangan baterai saat mati lampu
- Menstabilkan tegangan (stabilizer)
- Melindungi dari lonjakan tegangan
- Garansi UPS rusak ganti baru selama min. 2 tahun termasuk baterai
- Cocok untuk aplikasi IT ataupun non IT

Series	Referensi	Deskripsi	Back up time @half load	Back up time @full load	Harga (Rp) <i>(Sebelum PPN)</i>
Back-UPS Connect	CP12010LI-GR	Network Power supply with battery backup, 12Vdc, 1A, CEE7, lithium battery	120 menit@3W; 60 menit@7W		747.300
	BV500I-MS	500VA/300W, AVR, Universal Outlet, 230V	5.9 menit@150W; 0.1 menit@260W		1.287.700
Easy UPS (BV)	BV650I-MS	650VA/375W, AVR, Universal Outlet, 230V	5.7 menit@188W; 0.1 menit@320W		1.465.800
	BV800I-MS	800VA/450W, AVR, Universal Outlet, 230V	6.7 menit@225W; 0.4 menit@450W		1.729.600
	BV1000I-MS	1000VA/600W, AVR, Universal Outlet, 230V	2.8 menit@300W; 0.3 menit@450W		1.973.600
Easy UPS (BVX)	BVX700LUI-MS	700VA/360W, 230V, AVR, USB Charging Universal Sockets	5 menit@180W; 0.2 menit@290W		1.335.700
	BVX900LI-MS	900VA/480W, 230V, AVR, Universal Sockets	7.8 menit	1 menit	2.020.600
	BVX1200LI-MS	1200VA/650W, 230V, AVR, Universal Sockets	6.8 menit	1 menit	2.828.700
Back-UPS (BX)	BX750MI-MS	750VA/410W, 230V, AVR, Universal Sockets	7.2 menit	0.7 menit	2.928.500
	BX950MI-MS	950VA/520W, 230V, AVR, Universal Sockets	6.7 menit	0.5 menit	3.691.700
	BX1200MI-MS	1200VA/650W, 230V, AVR, Universal Sockets	6.8 menit	1 menit	4.243.200
	BX1600MI-MS	1600VA/900W, 230V, AVR, Universal Sockets	7.1 menit	1.1 menit	5.455.400
Back-UPS Pro (BR)	BX2200MI-MS	2200VA/1200W, 230V, AVR, Universal Sockets	7.7 menit	1.4 menit	6.418.400
	BR650MI	650VA/390W, 230V, AVR, LCD, 6 IEC outlets	10.5 menit	2.7 menit	3.579.500
	BR900MI	900VA/540W, 230V, AVR, LCD, 6 IEC outlets	11.4 menit	2.5 menit	5.382.900
	BR1300MI	1300VA/780W, 230V, AVR, LCD, 8 IEC outlets (2 surge)	10.6 menit	2.1 menit	8.889.900
	BR1600MI	1600VA/960W, 230V, AVR, LCD, 8 IEC outlets (2 surge)	10.4 menit	2.6 menit	9.529.300
	BR1200SI	1200VA/720W, 230V, 8 IEC outlets, Sine Wave, AVR, USB, LCD, User Replaceable Battery	14.2 menit	4 menit	9.342.000
Back-UPS Pro Gaming (BGM)	BR1600SI	1600VA/960W, 230V, 8 IEC outlets, Sine Wave, AVR, USB, LCD, User Replaceable Battery	13.5 menit	3.6 menit	10.008.900
	BR1500GI	1500VA/865W, 230V, 10 IEC outlets, AVR, LCD, User Replaceable Battery	12.3 menit	3.7 menit	10.688.300
	BGM2200-MSX	2200VA/1320W for Gaming, 230V, Pure Sine wave, LCD, White, Universal	5.8 menit	0.5 menit	9.010.300
	BGM2200B-MSX	2200VA/1320W for Gaming, 230V, Pure Sine wave, LCD, Black, Universal	5.8 menit	0.5 menit	7.508.600

Catatan : Untuk custom kapasitas baterai (back up time), hubungi distributor resmi Schneider



Back-UPS Connect



Easy UPS BV



Easy UPS BVX



Back-UPS BX



Back-UPS Pro BR



Back-UPS Pro Gaming BGM

Uninterruptible Power Supply (UPS) 1 Fasa

UPS 1 Fasa 0.5 - 3 kVA | Line Interactive

Melindungi perangkat elektronik Anda dari gangguan listrik

- Range **500VA - 3 kVA**
- Cadangan baterai saat mati lampu
- Menstabilkan tegangan (stabilizer)
- Melindungi dari lonjakan tegangan
- Garansi UPS rusak ganti baru selama min. 2 tahun termasuk baterai
- Cocok untuk aplikasi IT ataupun non IT



Series	Referensi	Deskripsi	Back up time @half load	Back up time @full load	Harga (Rp) (Sebelum PPN)
Smart-UPS C (SMC)	SMC1000I-2UC	1000VA/600W LCD 2U 230V with SmartConnect	16.9 menit	5.3 menit	12.298.300
	SMC1000IC	1000VA/600W LCD 230V with SmartConnect	16.9 menit	5.3 menit	10.798.900
	SMC1500I-2UC	1500VA/900W LCD 2U 230V with SmartConnect	15.6 menit	4.3 menit	16.426.600
	SMC1500IC	1500VA/900W LCD 230V with SmartConnect	15.6 menit	4.3 menit	14.242.600
	SMC2000I	2000VA/1300W LCD 230V	18.4 menit	6.8 menit	21.255.700
	SMC2000I-2U	2000VA/1300W LCD 2U 230V	14.1 menit	3.9 menit	25.901.800
	SMC3000I	3000VA/2100W LCD 230V	15.3 menit	5.1 menit	28.518.300
	SMC3000RMI2U	3000VA/2100W LCD 2U 230V	13.6 menit	4.3 menit	34.117.500
Smart-UPS T (SMT)	SMT750IC	750VA/500W LCD 230V with SmartConnect	15.9 menit	4.6 menit	11.156.500
	SMT750RMI2UC	750VA/500W LCD 2U 230V with SmartConnect	16.1 menit	5.5 menit	13.516.000
	SMT750RMI2UNC	750VA/500W LCD 2U 230V with Network Card	16.1 menit	5.5 menit	20.857.400
	SMT1000IC	1000VA/700W LCD 230V with SmartConnect	19.1 menit	5.8 menit	15.752.200
	SMT1000RMI2UC	1000VA/700W LCD 2U 230V with SmartConnect	31 menit	8.7 menit	20.560.400
	SMT1500IC	1500VA/1000W LCD 230V with SmartConnect	23.1 menit	6.5 menit	21.649.100
	SMT1500RMI2UC	1500VA/1000W LCD 2U 230V with SmartConnect	25.9 menit	7.2 menit	28.414.700
	SMT1500RMI2UNC	1500VA/1000W LCD 2U 230V with Network Card	25.9 menit	7.2 menit	35.993.200
	SMT2200IC	2200VA/1980W LCD 230V with SmartConnect	25 menit	8.7 menit	34.522.800
	SMT2200RMI2UC	2200VA/1980W LCD 2U 230V with SmartConnect	16.1 menit	5.5 menit	43.784.500
SMT2200RMI2UNC	2200VA/1980W LCD 2U 230V with Network Card	16.1 menit	5.5 menit	52.149.600	
SMT3000IC	3000VA/2700W LCD 230V with SmartConnect	17.2 menit	5.1 menit	43.515.600	
SMT3000RMI2UC	3000VA/2700W LCD 2U 230V with SmartConnect	11.5 menit	3.2 menit	58.063.600	
SMT3000RMI2UNC	3000VA/2700W LCD 2U 230V with Network Card	11.5 menit	3.2 menit	65.670.800	
Smart-UPS T Li-Ion (SMTL)	SMTL750RMI2UC	Lithium Ion, ShoDepth 750VA/600W, 230V with SmartConnect	12.9 menit	6.2 menit	22.122.700
	SMTL1000RMI2UC	Lithium Ion, ShoDepth 1000VA/800W, 230V with SmartConnect	16.1 menit	7.8 menit	32.200.500
	SMTL1500RMI3UC	Lithium Ion, ShoDepth 1500VA/1350W, 230V with SmartConnect	11.2 menit	5.2 menit	41.935.600
	SMTL2200RMI2UC	Lithium-Ion, 2200VA/1980W, 230V with SmartConnect Port	15.6 menit	7.5 menit	55.781.000
	SMTL2200RMI2UCNC	Lithium-Ion, 2200VA/1980W, 230V with SmartConnect Poand NMC	15.6 menit	7.5 menit	66.058.300
	SMTL3000RMI2UC	Lithium-Ion, 3000VA/2700W, 230V with SmartConnect Port	11.5 menit	5.3 menit	62.233.700
SMTL3000RMI2UCNC	Lithium-Ion, 3000VA/2700W, 230V with SmartConnect Poand NMC	11.5 menit	5.3 menit	71.578.100	
Smart UPS X (SMX)	SMX750I	750VA/600W Rack/Tower LCD 230V	37 menit	14.2 menit	15.585.100
	SMX750INC	750VA/600W Rack/TowerR LCD 230V with Networking Card	37 menit	14.2 menit	26.588.100
	SMX1000I	1000VA/800W Rack/Tower LCD 230V	24.2 menit	8.1 menit	18.528.700
	SMX1500RMI2U	1500VA/1200W Rack/Tower LCD 230V	17.2 menit	5.8 menit	29.513.800
	SMX1500RMI2UNC	1500VA/1200W Rack/Tower LCD 230V with Network Card	17.2 menit	5.8 menit	32.373.000
	SMX2200R2HVNC	2200VA/1980W Rack/Tower LCD 200-240V with Network Card	25.3 menit	9.8 menit	59.843.200
	SMX2200RMHV2U	2200VA/1980W Rack/Tower LCD 200-240V	25.3 menit	9.8 menit	46.492.000
	SMX3000RMHV2U	3000VA/2700W Rack/Tower LCD 200-240V	18.1 menit	6.3 menit	55.729.100
	SMX3000RMHV2UNC	3000VA/2700W Rack/Tower LCD 200-240V with Network Card	18.1 menit	6.3 menit	61.230.900

Catatan : Untuk custom kapasitas baterai (back up time), hubungi distributor resmi Schneider

Medan

UNIPLAZA Building, East Tower, Lt 3
Jl. Letjend. M.T. Haryono A-1
Medan - 20231
Ph. (62) (061) 457 9006
Fax. (62) (061) 455 5153

Batam

Batamindo Industrial Park
Jl. Beringin Blok 4
Muka Kuning, Batam Island - 29433
Ph. (62) (0770) 611 133
Fax. (62) (0770) 611 134

Balikpapan

Komplek Ruko Little China Blok AB 6 No 7,
Balikpapan Baru Balikpapan 76114,
Kalimantan Timur
Ph. (0542)-876722
Fax.(0542)-873709

Head Office Jakarta

Gedung Cibis Nine Park, 16th Floor
Jalan TB Simatupang No. 2,
Cilandak Timur, Jakarta Selatan
DKI Jakarta - 12560
Ph. (021) 5096 6000

APC By Schneider Electric

Gedung Cibis Nine Park, 16th Floor
Jalan TB Simatupang No. 2,
Cilandak Timur, Jakarta Selatan
DKI Jakarta - 12560
Ph. (021) 5096 6000

Surabaya

Gedung Graha Pena Lt. 3 Ruang 302
Jl. Jendral A. Yani no 88, Surabaya 60234
Ph. (62) (031) 8288333 (Hunting)
Fax. (62) (031) 8299901

Cikarang

East Jakarta Industrial Park (EJIP)
Plot 4B no.1-2, Lemah Abang
Bekasi 17550, Jawa Barat
Ph. (62) (21) 897 0203-8
Fax. (62) (21) 897 0209, 897 0085



Scan this QR
Code for our
partner location

CUSTOMER CARE CENTER

Sejak tahun 1999, PT Schneider Indonesia sangat menyadari pentingnya peranan Customer Care Center dalam menunjang dan meningkatkan pelayanan kepuasan pelanggan seiring dengan visi perusahaan.

Customer care center secara terus menerus mengembangkan dan meningkatkan kemampuan para karyawannya serta perangkat lunak dan perangkat keras sehingga kami dapat melayani seluruh pelanggan di wilayah nusantara.

Unduh aplikasi **mySchneider** dengan QR code scanning. Silakan akses aplikasi untuk:

- Informasi stock barang
- Informasi umum tentang produk
- Informasi harga

PELAYANAN

- Informasi Status Pesanan Barang
- Spesifikasi Produk
- Aplikasi Teknik
- Online Trouble Shooting
- Keluhan Pelanggan



Life Is On

Schneider
Electric

Hotline

1500055

F. (+62) (21) 750 4415-16

E. customercare.id@se.com

se.com/id